

2007

Replacement Parts Price Book

Residential & Commercial Water Heaters, Boilers and Storage Tanks

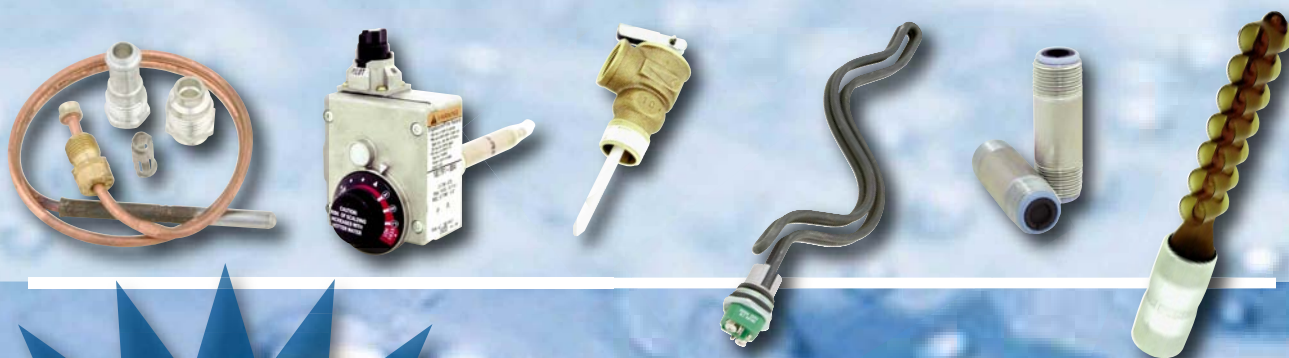

**New
24/7 Online
Parts Search**

www.hotwater.com/partscatalog/parts.htm

or visit our online parts section at

www.hotwater.com/parts.html

Prices Effective October 1, 2007

A.O. Smith
Water Heaters

www.hotwater.com

Table of Contents



Residential	PAGE
PREMIUM SCREW-IN ELEMENTS	3
MID-LINE SCREW-IN ELEMENTS	4
BASIC SCREW-IN ELEMENTS	5
ELEMENT ACCESSORIES	6
ELECTRIC THERMOSTATS	7
HIGH LIMIT CONTROLS	7
TEMPERATURE CONTROLS (Robertshaw®, Honeywell®, White Rodgers®).....	8,9
GAS HEATER PARTS	10
Thermocouples, Extenders, Pilot Tube Kits, Igniters & Gas Pilot Assemblies	
BLOWER ASSEMBLIES	10
WATER HEATER PARTS, GAS & ELECTRIC	11
Anode Rods, Dip Tubes, Spacers, Inlet/Outlet Nipples, T& P Valves & Extenders, Runoff Tubes	

Commercial	PAGE
FLANGED ELEMENTS	12
ELECTRIC THERMOSTATS	12
CONTACTORS & TRANSFORMERS	13
HIGH LIMIT CONTROLS	13
GAS VALVES - (Natural & Propane)	14
LIGHT COMMERCIAL GAS VALVES	14
PILOT BURNERS (Johnson®, White Rodgers®, Robertshaw®) & Assorted Gas Parts.....	15
INTERMITTENT IGNITION CONTROLS	15
HOT SURFACE IGNITERS	16
TEMPERATURE CONTROLS	16
RELIEF VALVES	17
FLUE DAMPERS/DRAFT HOODS	17
COILS & HEAT EXCHANGERS	18
PUMPS (Bell & Gossett & TACO) & THERMAL BALANCER	19
SYSTEM PACKAGES (Heat Exchangers).....	20
LEGEND/GENESIS VENTING COMPONENTS	21

Tools, Accessories & Delimiting	PAGE
ACCESSORIES & TOOLS	22
Screw Plug Element Remover,	
Gas Pressure Gauge Kit, Water Pressure Gauge Kit, Milliamp-Millivolt Gas Test Kit,	
Digital Multimeter, Wireless Water Detective	
SEQUENCE/RESETTING CONTROL PANELS	23
BRASS & PLASTIC DRAIN VALVES & FLUSH VALVE	23
THERMOMETERS, SAFETY PANS, WATER HEATER STANDS &	
SAFETY FLOW SWITCHES	23, 24
DELIMITING PRODUCTS	25
Main Burner Assembly Guide	26,27
Burner Reference Guide	28
Contact Information	29

Parts Ordering Information

Ordering	Please have complete part number(s) and description(s) available when ordering. We also suggest you have the model, series and serial number of the model available when calling. NOTE: Minimum parts order amount is \$50.00 list (\$25.00 net). Refer to owner's manual for a list of all available repair parts.			
Contact Us	Phone: 1-800-433-2545 Fax: 1-800-433-2515			
Order Processing Time	Regular-2 work days Accelerated (by request at added cost)-next working day. Acceptable orders are considered received the following business day when received after 3:00 pm Central Time	Shipping Method Chart		
		CARRIER	REGULAR	ACCELERATED
		UNITED PARCEL SERVICE		
		1. UPS - Ground	X	
		2. UPS 2nd day air - limited to U.S.		X
		3. UPS 3rd day air - limited to U.S.		X
Departure Schedule (Monday-Friday)	3:00 p.m. Central Time	4. UPS - Next day air - area limited		X
		AIR EXPRESS		X

Packaging	Parts are available in a variety of packaging options, including Bagged and Boxed. Bagged where available is the standard and will be shipped unless otherwise specified. Packing codes will be listed on the end of each part number; (example: 9000071015) packaging codes are as follows: Bagged 015, 115 and 215, Boxed 005, 105 and 205. All parts prices shown are for parts ordered in carton quantities. The number of parts per carton is shown. Add 25% to prices shown when ordering less than carton quantities. Please order by Part Number and Description. Specify packaging if other than standard.
Acceptance of Order	The price sheet does not constitute an offer to sell. All orders are subject to final approval and acceptance. Prices, terms and specifications are subject to change without notice. Billing prices are those in effect on the date of shipment.
Terms	2% 10th Prox., Net 25th
Freight Allowance	LTL freight shipments will be made collect, unless otherwise specified. UPS and Parcel Post shipments will be prepaid and the cost included in the invoice. Freight will be allowed and prepaid on single destination parts orders over \$1,500.00, suggested list (\$750.00 Net), (excluding UN LIME) within the continental United States. Air freight charges are not included. For UN LIME Delimer, 200 gallons or more of UN LIME will be shipped freight prepaid as outlined above. 100 gallons or more (up to 199 gallons) of UN LIME, in conjunction with list price orders of \$1,500.00 or more will be shipped freight prepaid as outlined above.
Cancellation Policy	Cancellations made after product has shipped, will be subject to a 25% restocking charge plus any freight and damages incurred.
Return of Merchandise	No material may be returned for adjustment of any nature whatsoever without an authorized return number. A 25% restocking charge will be applied. Return of an A.O. Smith replacement part requires approval. All returned parts should be returned in SALEABLE condition and all kits should be returned in their ENTIRETY with components. Acceptance is subject to our inspection and a 25% restocking charge. ASMMI00105 tags may not be used to return SALEABLE parts.
Error Claims	Claims for errors in shipment, invoicing and/or credits must be made to A. O. Smith Water Heaters, 500 Tennessee Waltz Parkway, Ashland City, TN 37015. For all shipments, invoicing and/or credit errors claims not made with 30 days of delivery of shipment, date of invoice and/or date of credit, shall be deemed waived.

PRICES IN EFFECT AT TIME OF SHIPMENT WILL GOVERN, AND ARE SUBJECT TO CHANGE WITHOUT NOTIFICATION.

Limited Warranty

A. O. Smith replacement parts carry a limited warranty against defects in material and workmanship. A. O. Smith replacement parts found to be defective within the expressed warranty period will be replaced, provided they are returned prepaid within 30 days of the date of failure and our inspection validates the claim. A completed form ASMMI00105 Parts Return Tag must be submitted with the defective part. Tags are available from A. O. Smith Water Heaters, 500 Tennessee Waltz Parkway • Ashland City, TN 37015 or phone your request to 888-901-3240 or fax to 615-778-0874.

Under new UPS Authorized Return Service (A.R.S.) Program, A. O. Smith will pay the return freight on defective parts replaced under warranty. **Please note that UPS Authorized Return Service (A.R.S.) labels are NOT to be used for coils, heat exchangers or new (unused) parts being returned for credit.**

No other warranty, either expressed or implied (including but not limited to a warranty of merchantability) is made on behalf of A. O. Smith Water Heaters with respect to replacement parts.

Premium Screw-in Elements



Residential Premium Screw-in Elements

FOUR REASONS THEY ARE BETTER

1. Incoloy nickel-alloy sheathing resists overheating caused by scale, sludge and dry firing.
2. Best grade of magnesium oxide moves heat quickly from wire to sheath and provides maximum electrical insulating value for long life.
3. Finest quality Nichrome heating wire conducts electricity evenly throughout its length and eliminates hot spots to cause premature failure.
4. Extra long cold pins means less heat transfer to elements flange, terminal and wiring which means more heat to the water.

FEATURES & BENEFITS

- Nickel-Alloy Sheathing - better than stainless steel
- Our long lasting element - lowest practical watt density
- For residential & light commercial use
- Includes gasket
- Ideal for hard water areas
- 1 1/4" Screw-in element

INCOLOY NICKEL-BASE SHEATH ELEMENTS

Part Number	Volts	Watts	Max. "A" Dim. (Inches)	Bagged List Price
9004279115	120	1500	9	\$ 24.40
9004284115	208	2000	9	31.45
9004753115	208	5000	16 1/2	44.00
9004289115	208	6000	16 1/2	41.95
9004290115	240	1500	9	27.05
9004283115	240	2000	11 1/2	25.70
9004291115	240	2500	11	40.75
9000664015	240	3000	13 1/2	41.85
9004292115	240	3500	13 3/4	27.30
9004751115	240	4000	16	40.75
9003210115	240	4500	13 3/4	29.85
9004293115	240	5000	16	37.90
9004294115	240	5500	13 1/2	33.60
9004749115	240	6000	16 1/2	36.50
9004296115	277	3000	16 1/2	43.10
9004297115	277	4500	16 1/2	47.85
9004298115	480	2000	16	29.00
9004300115	480	3000	16 1/2	42.80
9004763115	480	4000	16 1/2	47.30
9004760115	480	4500	16 1/2	47.85
9004761115	480	5000	16 1/2	47.10
9004762115	480	6000	16 1/2	45.60

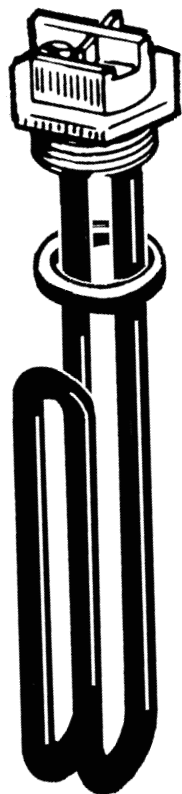

SCREW-IN ELEMENT FOR ELC-2 & ELC 4 MODELS

Part Number	Volts	Watts	Max. "A" Dim. (Inches)	Boxed List Price
9005406105	120	1500	8	\$ 69.45

Mid-Line Screw-in Elements

CORROGARD ZINC-PLATED COPPER ELEMENTS

Part Number	Volts	Watts	Max. "A" Dim. (Inches)	List Price
9004777105	120	1500	11	\$ 12.15
9003947115	120	2000	11 1/2	13.50
9002859115	120	2500	11 1/2	21.50
9002862115	120	3000	11 3/4	17.35
9004705115	208	1500	13 1/2	18.20
9002858115	208	2000	13 1/2	26.10
9002961115	208	2500	13 1/2	20.35
9004706115	208	3000	13 1/2	21.30
9004489105	208	4000	13 1/2	23.60
9002645115	208	4500	13 1/2	20.35
9001224115	208	5000	16	35.50
9003952115	208	6000	16	20.45
9000143115	240	1000	8	12.50
9002864115	240	1500	11	22.90
9000145115	240	2000	13 1/2	13.90
9002860115	240	2500	12 1/2	14.35
9003959115	240	3000	11 3/4	14.55
9004712115	240	3500	13 1/2	15.60
9002868115	240	4000	13 1/2	16.25
9003950115	240	4500	13 1/2	14.45
9000150115	240	5000	16	17.00
9002867115	240	5500	16	18.10
9003952115	240	6000	16	20.45
9004708115	277	1500	11 1/2	19.60
9004709115	277	2000	13 1/2	20.95
9002890115	277	2500	13 1/2	28.25
9003958115	277	3000	11 3/4	24.10
9003960115	277	4500	13 1/2	26.20
9002874115	277	6000	15 1/2	34.25
9002861115	480	2500	11 1/2	35.40
9003961115	480	3000	13 3/4	24.95
9002869115	480	4000	13 1/2	35.30
9004710115	480	4500	16	23.00
9004711115	480	5000	16	29.45
9002875115	480	6000	13 1/2	41.95

FEATURES & BENEFITS ►

- Improved durability
- Lowest practical watt density for size
- For residential & light commercial use
- Zinc plated for corrosion protection
- Includes gasket
- 1 1/4" Screw-in element



Basic Screw-in Elements



Basic Screw-in Elements

HIGH - WATT DENSITY ELEMENTS

Part Number	Volts	Watts	Max. "A" Dim. (Inches)	Bagged List Price
9004738115	120	750	8	\$ 11.75
9004739115	120	1000	8	11.35
9004740115	120	1500	8	10.90
9004741115	120	2000	10	10.90
9004742115	120	2500	10	11.45
9004746115	208	6000	12	23.00
9004745115	240	1500	8	11.35
9003946115	240	2000	8	11.35
9003954115	240	2500	10	11.15
9003955115	240	3000	10	11.25
9003948115	240	3500	12	11.35
9003956115	240	4000	12	11.75
9001811115	240	4500	12	10.90
9003957115	240	5000	10	14.75
9003951115	240	5500	12	14.25
9001225115	480	4500	12	24.80
9004748115	480	6000	12	29.65

FEATURES & BENEFITS ▶

- For residential & light commercial use
- Zinc plated for corrosion protection
- Includes gasket
- 1 1/4" Screw-in element

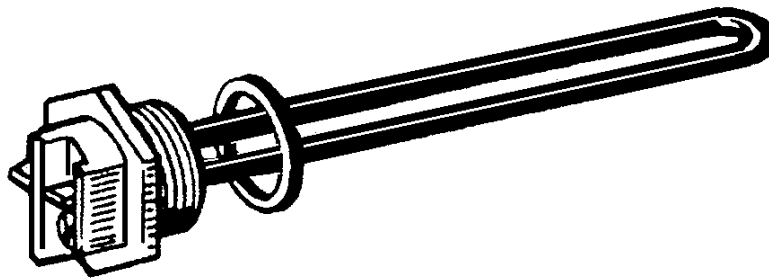

Element Accessories

REPLACEMENT SCREWS, GASKETS AND PLUGS

Part Number	Description	List Price
A 9004704115	Square flange - 2 1/2" bolt circle - 1 49/64" centers - most widely used flange design includes gasket.	\$ 9.75
G 9005897015	Plug for 1 1/4" screw-in element opening.	3.55
H 9004642115	SCREW PLUG ELEMENT REMOVER-Heavy duty all steel construction with chromium plated finish. Will remove the most stubborn of elements.	41.95

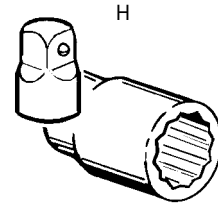
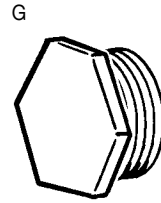
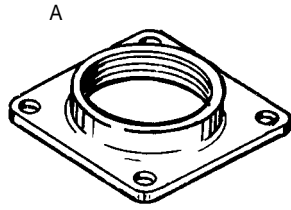

Electric Thermostats



Electric Thermostats & High Limit Controls

Therm-O-Disc® ELECTRIC THERMOSTATS

Part Number	Description	List Price
A 9004714115	Lower, single pole, single throw thermostat, style 4090 series 59T, temperature range 110°F to 150°F, without high limit.	\$ 11.35
A 9004716115	Upper, single pole, double throw thermostat, style 4100 series 59T, temperature range 110°F to 150°F, without high limit.	14.35
A 9004373115	Thermostat for Models FPSE, PGSE, FPD, FPST	15.00
B 9004784115	Lower, single pole, single throw thermostat, style 4190 with high limit.	21.20
C 9004715115	Lower, single pole, single throw thermostat, style 4000 series 59T, temperature range from 110°F to 170°F	18.50
D 9003896215	Upper, double pole, double throw thermostat. Type 89T33 Series 331635, temperature range 120°F to 180°F, high limit 200°F.	32.65
D 9004427115	Single pole, single throw thermostat - w/high limit incorporated as one piece unit (type 89T13). Temp. range 90°F to 150°F, high limit 170°F	19.70
D 9004428115	Single pole, double throw thermostat - w/high limit incorporated as one piece unit (type 89T33). Temp. range 90°F to 150°F, high limit 170°F	25.35

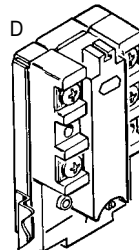
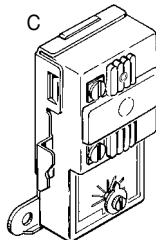
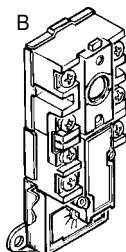
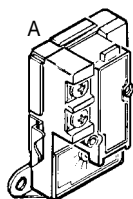

APCOM THERMOSTATS

Part Number	Model Number	Description	List Price
9001954015	WH10-A	Upper thermostat with E.C.O. - 240 V.A.C. - Adjustable	\$ 21.50
9000507015	WH9	Lower thermostat - 240 V.A.C.	10.70
9000509015	WH9-6	Single element heater thermostat with E.C.O. 120/240 V.A.C.	18.95

High Limit Controls

HIGH LIMIT CONTROLS

Part Number	Description	List Price
E 9004718115	Double pole, single throw high limit control, opens circuit at 170°F, manual reset, can't be blocked shut, style 4400 series 66T.	\$ 9.95
F 9004778115	(Prior to 1975) Double pole, single throw high limit control, opens circuit at 190°F, manual reset, can't be blocked shut, style 1610 series HLC.	15.50
G 9004374115	Energy cut-off for Models FPSE, PGSE, FPD, FPST	11.45

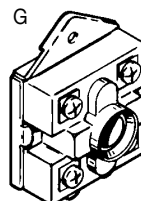
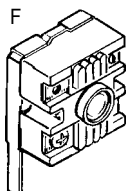
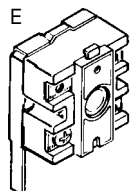

Temperature Controls

ROBERTSHAW® CONTROLS

Part Number	Description	List Price
B 9005400105	Temperature control for NATURAL gas, 3 1/2" manifold pressure setting, pilot pressure fixed w/ECO cut off at 195°F; Temperature range to 160°F. (A=1 1/4")	\$115.55
B 9005401105	Temperature control for NATURAL gas, 3 1/2" manifold pressure setting, pilot pressure fixed w/ECO cut off at 195°F; Temperature range to 160°F. (A=2")	143.90

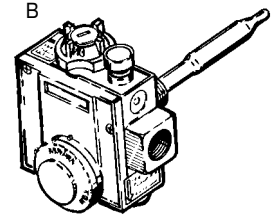

HONEYWELL® SMARTVALVE™ CONTROLS

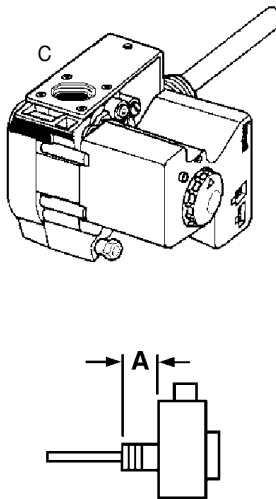

Part Number	Description	List Price
C 9004440105	Gas control for NATURAL gas, 3 1/2" manifold pressure setting. Maximum temperature range 160°F. (A=1.4)	\$ 315.00
C 9004441105	Gas control for PROPANE gas, 10" manifold pressure setting. Maximum temperature range 160°F. (A=1.4)	318.65
C 9004442105	Gas control for NATURAL gas, 3 1/2" manifold pressure setting. Maximum temperature range 160°F. (A=2.5)	318.65
C 9004443105	Gas control for PROPANE gas, 10" manifold pressure setting. Maximum temperature range 160 °F. (A=2.5)	323.15
C 9004444105	Gas control for NATURAL gas, 3 1/2" manifold pressure setting. Maximum temperature range 180 °F. (A=2.06")	327.85
C 9004445105	Gas control for PROPANE gas, 10" manifold pressure setting. Maximum temperature range 180°F. (A=2.06")	363.25
C 9004446105	Gas control for NATURAL gas, 3 1/2" manifold pressure setting. Maximum temperature range 160°F. (A=2.06")	335.00
C 9004447105	Gas control for PROPANE gas, 10" manifold pressure setting. Maximum temperature range 160°F. (A=2.06")	353.85

WHITE RODGERS® INTELLIVENT™ CONTROLS

Part Number	Description	Where Used		List Price
		Model	Series	
9004240005	Gas control for NATURAL gas, 3 1/2" manifold pressure setting. Maximum temperature range 160°F. (A=1.72")	FPD/FPSH/, GPSH-40 & 50, PR6 40/50 XCVIT	270 & 100	\$ 313.60
9004310005	Gas control for PROPANE gas, 10" manifold pressure setting. Maximum temperature range 160°F. (A=1.72")	FPD/FPSH/, GPSH-40 & 50, PR6 40/50 CCVIT	271 & 101	322.20
183760-002	Gas control for NATURAL gas, 3 1/2" manifold pressure setting. Maximum temperature range 160°F. (A=2.82")	FPCR/FPST-40 & 50, GPCR 40/50 Series 100/102, GPSX 50 Series 100/200, GPSX 50L/50Q Series 200, PR6 40/50 XCVIT Series 100/102	270	341.00
9004464005	Gas control for PROPANE gas, 10" manifold pressure setting. Maximum temperature range 160°F. (A=2.82")	FPCR-40, FPCR/FPST-50, GPCR 40/50 Series 101/103, GPSX 50 Series 101/201, GPSX 50L/50Q Series 201, PR6 40/50 CCVIT 2 Series 101/103, PR6 50 CCVIT 5 Series 201	271	324.70
9004465005	Gas control for NATURAL gas, 3 1/2" manifold pressure setting. Maximum temperature range 160°F. (A=2.38")	FPSH-75	270	318.50
9004466005	Gas control for PROPANE gas, 10" manifold pressure setting. Maximum temperature range 160°F. (A=2.38")	FPSH-75	271	310.20
9004467005	Gas control for NATURAL gas, 3 1/2" manifold pressure setting. Maximum temperature range 180°F. (A=2.38")	BTF-75, BTI-80, BTI/BTV-100	270 & 110	316.10
9003691005	Gas control for NATURAL gas, 4" manifold pressure setting. Maximum temperature range 160°F. (A=1.72") Replaces: 183760-008	GPDH-40,40L & 40Q, GPDH/GPDT-50, GPDH/GPSX/GPDT-50Q, GPDH/GPSX/GPDT-50L, PR6 40/50 NOVIT, PR6 40/50 NOVIT CGA, PR6 40/50 NRVIT Z, PR6 40/50 NRVIT CGAZ, PR6 50 NRVIT 5Z, PR6 50 NRVIT 5 CGAZ, 409.7342, HIN412 40P	100	305.50
9003629005	Gas control for NATURAL gas, 4" manifold pressure setting. Maximum temperature range 160°F. (A=2.38") Replaces: 183760-010 and 183760-012	GPST-40L, GPST-50Q & 50L, GPDH-75, 75Q & 75L	100	339.60
9003630005	Gas control for PROPANE gas, 10" manifold pressure setting. Maximum temperature range 160°F. (A=2.38")	GPST-40L, GPST-50Q & 50L, GPDH-75, 75Q & 75L	101	283.85

Residential Temperature Controls



Temperature Controls

WHITE RODGERS® INTELLIVENT™ CONTROLS (CONT'D)

Part Number	Description	Where Used	List Price
9005108005	THERMOSTAT GAS W/R (NAT) 1.45" SHANK Replaces: 184768-004	Used on PR6 40/50 NCVIT, PR6 40/50 NOVIT, HJ6 40/50 NOVIT, 8 40/50 NAVIT	\$293.40
9005109005	GAS CONTROL INTELLIVENT G VALVE LP 1.45" Replaces: 184768-005	Used on PR6 40/50 PCVIT, PR6 40/50 POVIT, HJ6 40/50 POVIT, 8 40/50 PAVIT	300.80
9005112005	THERMOSTAT GAS W/R (LP) 1.25" SHANK Replaces: 184768-001	Used on GPSH 40/50 SERIES 101/201, PR6 40/50 CCVIT, PR6 40/50 COVIT, HR6 40 COVIT, HR6 50 XOVIT, 8 40/50 CAVIT, 6 40/50 COVIT, 153.332861, 153.33287 HA, 153.332880, 153.332890 HA, 409.734200	293.90
9005113005	THERMOSTAT GAS W/R (NAT) 2.25" SHANK Replaces: 184768-002	USED ON GPCR 40/50 SERIES 100/200, PR6 40/50 XCVIT, HRN412 40P/50P/50V, GPST 40Q/50Q/40L/50L SERIES 100/200, PR6 40/50 XRVIT, A6 40/50 XQVIT L2, A6 40/50 XRVIT L2, GPSX-50/50Q/50L SERIES 100/200, A6 50 XQVIT L5, A6 50 XRVIT L5, 409.734210	295.00
9005114005	THERMOSTAT GAS W/R (LP) 2.25" SHANK Replaces: 184768-003	USED ON GPCR 40/50 SERIES 101/201, PR6 40/50 CCVIT, HRN412 40P/50P/50V, GPST 40Q/50Q/40L/50L SERIES 101/201, PR6 40/50 CRVIT, A6 40/50 CRVIT L2, A6 40/50 CQVIT L2, GPSX-50/50Q/50L SERIES 101/201, A6 50 CQVIT L5, A6 50 CRVIT L5, 409.734210.	302.40
9004312005	THERMOSTAT GAS W/R (NAT) 1.25" SHANK Replaces: 184768-000	Used on GPSH 40/50 series 100/200, PR6-40/50 XCVIT, PR6-40/50 XOVIT, HR6 40/50 XOVIT, 8 40/50 XAVIT, 6 40/50 XOVIT, 153.332960, 153.33297 HA, 153.332980, 153.33299 HA	259.40
9005962005	THERMOSTAT GAS W/R (NAT) 1.25" SHANK Replaces 184960-000	Used on GPVH 40/50 series 100, GS6 40/50 series 100, HV6 40/50 series 100, 840/850 YAVIT series 100, 640/650 YBVIS series 100, 153.333960, 153.333980	314.30
9005963005	THERMOSTAT GAS W/R (LP) 1.25" SHANK Replaces 184960-001	Used on GPVH 40/50 series 101, GS6 40/50 series 101, HV6 40/50 series 101, 840/850 HAVIT series 101, 640/650 HBVIS series 101, 153.333960, 153.333980	301.50
9005964005	THERMOSTAT GAS W/R (NAT) 2.25" SHANK Replaces 184960-002	Used on GPVR 40 series 100, GS6-40/50 series 100, HVN412 40/50P series 100	322.10
9005965005	THERMOSTAT GAS W/R (LP) 2.25" SHANK Replaces 184960-003	Used on GPVR 40 series 101, GS6-40/50 series 101, HVN412 40/50P series 101	318.50
9005110005	THERMOSTAT GAS W/R (NAT) 1.45" SHANK Replaces 184960-004	Used on GPDH 40/40Q/40L/50, PR6-40/50 XBPDT, A6-40 XAPDT, A6-40 XBPDT, HR6-40/50 XBPDT, 6-40/50 XBPDT, GPDT 50/50Q/50L, PR6-50 XRPDT, A6-50 XQPDT/XRPDT	313.60
9005111005	THERMOSTAT GAS W/R (LP) 1.45" SHANK Replaces 184960-005	Used on GPDH 40/40Q/40L/50, PR6-40/50 CBPDT, A6-40 CAPDT, A6-40 CBPDT, HR6-40/50 CBPDT, 6-40/50 CBPDT, GPDH 40,40Q,40L,50, GPDT50/50Q/50L, PR6-50 CRPDT, A6-50 CQPDT/CRPDT	313.60
9004463205	CONTROL WATER HEATER NATURAL Replaces: 183760-016	Used on BTN 80/100 series 110	343.60

WHITE RODGERS® CONTROLS

FEATURES & BENEFITS

- Safe lighting features permits lighting without danger of main gas flow
- 100% gas shutoff if pilot fails

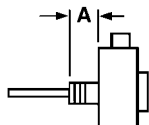

Part Number	Description	List Price
D 9004703105	Temperature control for NATURAL gas, 3 1/2" manifold pressure setting, pilot pressure fixed w/ECO cut off at 195°F Temperature range to 160°F. (A = 1 1/4")	\$ 86.15
D 9004353105	Temperature control for NATURAL gas, 3 1/2" manifold pressure setting, pilot pressure fixed w/ECO cut off at 195°F Temperature range to 160°F. (A = 2 1/2")	95.10
D 9004028205	Temperature control for NATURAL gas, 4" manifold pressure setting, pilot pressure fixed w/ECO cut off at 195°F Temperature range to 160°F. (A = 1 1/4")	114.80
D 9003739105	Temperature control for NATURAL gas, 4" manifold pressure setting, pilot pressure fixed w/ECO cut off at 195°F Temperature range to 160°F. (A = 2 1/2")	120.40
9003407005	Temperature Control for NATURAL gas, 4" manifold pressure setting, pilot pressure fixed w/ECO cut off at 195°F Temperature range to 160°F. (A=1 1/4")	95.00
9003638005	Temperature Control for NATURAL gas, 4" manifold pressure setting, pilot pressure fixed w/ECO cut off at 195°F Temperature range to 160°F. (A = 2 1/2")	100.50
E 9004713105	Temp. control for PROPANE gas, 10" manifold pressure. setting, pilot pressure fixed w/ECO cut off at 195°F Temp. range to 160°F. RIGHT HAND THREAD BURNER TUBE CONNECTION. (A = 1 1/4")	217.00
E 180192-003	Temp. control for PROPANE gas, 10" manifold pressure setting, pilot pressure fixed w/ECO cut off at 195°F Temp. range to 160°F. RIGHT HAND THREAD BURNER TUBE CONNECTION. (A = 2 1/2")	235.95
E 9003408005	Temp. control for PROPANE gas, 10" manifold pressure setting, pilot pressure fixed w/ECO cut off at 195°F Temp. range to 160°F. LEFT HAND THREAD BURNER TUBE CONNECTION. (A = 1 1/4")	236.20
E 9003639005	Temp. control for PROPANE gas, 10" manifold pressure setting, pilot pressure fixed w/ECO cut off at 195°F Temp. range to 160°F. LEFT HAND THREAD BURNER TUBE CONNECTION. (A = 2 1/2")	252.90
F 9003696005	Gas Safety Thermostat Cover w/lock & key. Prevents unwanted tampering of water temperature change & fits most White Rodgers T-stats.	40.15

*Order for replacement on propane heaters manufactured after January 1, 1993.

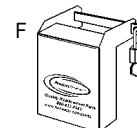
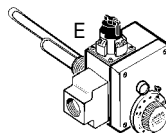
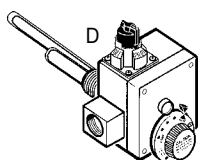

Phone: 800-433-2545 Fax: 800-433-2515

Residential Temperature Controls

Gas Heater Parts

THERMOCOUPLES, EXTENDERS & MORE

Part Number	Description	List Price
A 9000876015	THERMOCOUPLE 30 millivolt output, Up to 18" long.	\$ 9.40
A 9000056015	THERMOCOUPLE 30 millivolt output, 19-24" long.	10.05
A 9000496015	THERMOCOUPLE 30 millivolt output, 25-30" long.	11.25
A 9000497015	THERMOCOUPLE 30 millivolt output, 31-36" long.	12.00
B 9004473115	PILOT TUBE KIT 24" of 1/4" aluminum tubing. (Use when tubing has been damaged or is too short after control replacement).	4.40
B 9004722115	PILOT TUBE KIT 16" of 1/8" aluminum tubing.	6.10
B 9004723115	PILOT TUBE KIT 20" of 1/8" aluminum tubing with compression fittings.	6.30
C 9004966115	PIEZO IGNITER, spark igniter for Models FGCG/PGCG.	16.35
D 9004372115	PIEZO NATURAL GAS PILOT ASSEMBLY, for Models FGCG/PGCG.	28.80
D 9004371115	PIEZO L.P. GAS PILOT ASSEMBLY, for Models FGCG/PGCG.	28.80
E 9004374115	Energy cut-off for Models FPSE, PGSE, FPD, FPST	11.45

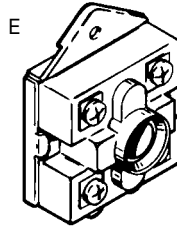
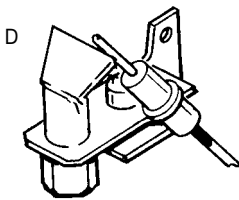
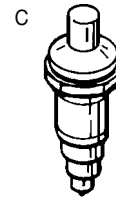
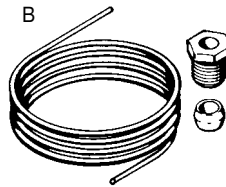
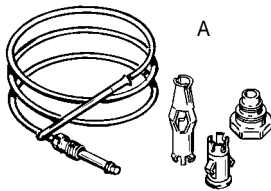

Blower Assemblies

Part Number	Description	List Price
F 180447-000	FPV/KPV/FPVH.	\$ 378.65
F 9004363105	FPS prior to 226/227 series.	450.60
F 9004449105	FPD-40/50, series 250/251	451.75
F 9004419105	FPS-75, FPSE-75 series 230-235	452.95
F 9004425105	FPD-40/50, series 230/231/234/235	420.00
F 183279-001	FPST-50, series 250/251	194.65
F 9004434105	FPSH-40/50, series 234/235	483.65
F 9004453105	FPSH-40/50, series 236/237	435.30
F 9004456105	FPSH-40/50, series 250/251, FPST-50, series 250/251	424.70
F 9004306005	FPSH-40/50, FPCR-40/50, series 260/261	375.05
F 9004565105	BTI-80/100 series 104	444.70
F 9004568105	FPSE-75 series 250/251, BTF-75 series 100/101	592.15
F 9004581105	BTF-75, series 100, FPSH-75, series 260	375.05
F 9004656105	(Ametek/Jakel) replacement for FPS-40 & 50	420.00
BLOWER PRESSURE SWITCHES		
G 9004654105	For Amtek/Jakel 21208 (FS-6070A-1833)	\$ 50.70
G 9004659105	For 182273-000 (FS-6085A-1903) - Inlet	48.35
G 9004660105	For 182273-000 (FS-6086A-1904) - Outlet	48.35

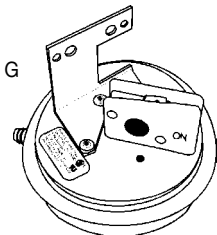
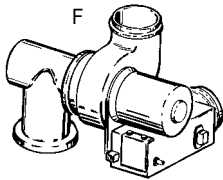

Gas & Electric Heater Parts



Gas & Electric Heater Parts

ANODE RODS

Part Number	Anodes	Length		Rod Material	List Price
		Nipple	Overall		
A 9005742105	3/4" flexible plug anode rod	—	48	Aluminum	\$ 69.55
A 9005973005	3/4" flexible plug anode rod	—	48	Magnesium	79.40
B 9005975005	3/4" flexible outlet anode rod	—			31.90
C 9006212005	3/4" outlet anode rod	3	38 13/16	Aluminum	35.85
C 9006211005	3/4" outlet anode rod	3 1/4	44 3/8	Aluminum	42.25
D 9000029005	3/4" standard aluminum anode rod	—	29"	Aluminum	19.90
D 9001829005	3/4" standard magnesium anode rod	—	32"	Magnesium	25.25
D 9001453005	3/4" KA-90 anode rod. For smelly water	—	42"	Magnesium	63.00

DIP TUBES, SPACERS & SCREEN

Part Number	Dip Tubes	Length		Tube Material	List Price
		Nipple	Overall		
E 9003918005	3/4" drop-in dip tube	—	26	Polypropylene	\$ 11.50
E 9001938005	3/4" drop-in dip tube	—	36	Polypropylene	12.30
E 9005885105	3/4" drop-in dip tube	—	45	Polypropylene	12.10
E 9006254005	3/4" drop-in dip tube	—	52	Polypropylene	20.40
NI 042589-000	5/16" thick spacer	—	—	—	3.00
NI 042589-001	5/8" thick spacer	—	—	—	3.00
NI 9003406115	Air intake screen	—	—	—	3.00

NI = Not illustrated.

*All dip tubes come with spacers. NI-Not illustrated. **183350-XX replaces 21062-XX series.

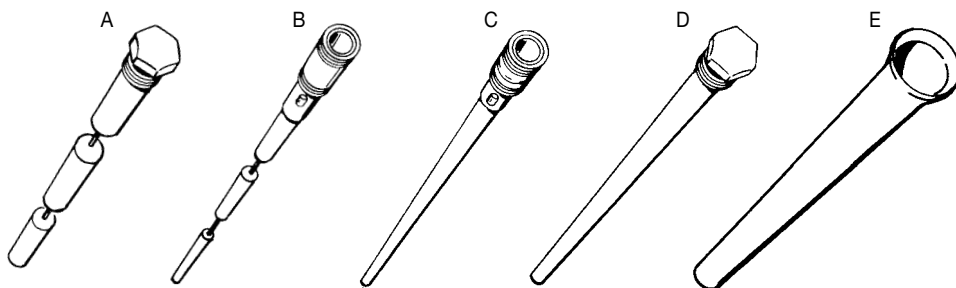

INLET/OUTLET NIPPLES, T&P VALVES AND EXTENDERS, RUNOFF TUBES

Part Number	Description	List Price
F 9000071005	Temperature and pressure relief valve, 3/4" male inlet, 3/4" female outlet. Temperature relief at 210°F, pressure relief at 150PSI, 100,000 BTUH	\$ 12.10
F 9003741005	A.G.A. rating, 200,000 BTUH ASME rating.	15.20
G 9000398015	T & P extender, 3/4" x 3 1/4" zinc dichromate nipple w/polysulfone liner	21.10
G 9005265115	T & P extender, 3/4" x 2" zinc dichromate nipple w/polysulfone liner	6.85
NI 9006196005	3/4" x 60" valve runoff tube	6.40

Great impulse item... Keep them near the counter!

NI = Not illustrated.

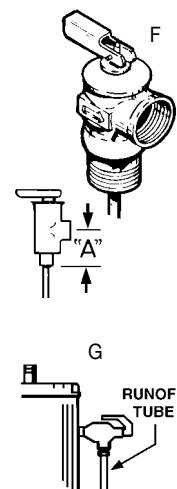

Flanged Elements

FEATURES & BENEFITS

- Used on DSE, CMC, SU & DVE/DHE models over 125 gallons
- Incoloy nickel-alloy sheathing
- Medium watt density
- For commercial use. Includes gasket
- For 2 1/2" bolt-circle, round and square flanges
- Strong, forged steel flanges

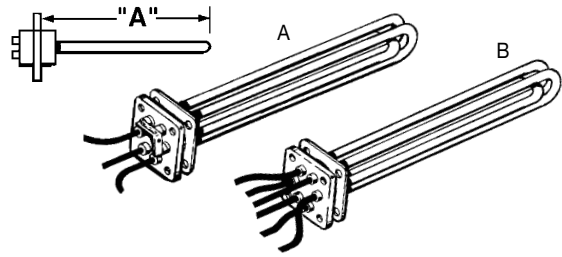

FLANGED INCOLOY ELEMENTS

Part Number	Volts	KW	Max. "A" Dim. (Inches)	List Price
B 9004832105	208	5	9 1/2	\$ 303.15
B 9004836105	208	6	12	310.20
B 9004837105	208	7.5	14 1/2	330.30
B 9004839105	208	10	15 1/2	330.30
B 9004841105	208	12	15 1/2	330.30
B 9004842105	208	15	15 1/2	330.30
B 9004833105	208	15	22	368.10
B 9004834105	208	18	15 1/2	330.30
B 9004835105	208	3	9 1/2	330.30
B 9004846105	240	3	9 1/2	303.15
B 9004847105	240	5	9 1/2	303.15
B 9004848105	240	6	12	317.25
B 9004849105	240	7.5	14 1/2	330.30
B 9004850105	240	9	15 1/2	330.30
B 9004851105	240	10	15 1/2	315.00
B 9004852105	240	12	15 1/2	330.30
B 9004843105	240	15	15 1/2	330.30
B 9004844105	240	15	22	370.35
B 9004845105	240	18	15 1/2	330.30

Part Number	Volts	KW	Max. "A" Dim. (Inches)	List Price
A 9004853105	480/277	2	9 1/2	\$ 303.15
A 9004858105	480/277	3	9 1/2	303.15
A 9004859105	480/277	5	9 1/2	330.30
A 9004860105	480/277	6	12	317.30
A 9004861105	480/277	7.5	14 1/2	330.30
A 9004865105	480/277	9	15 1/2	330.30
A 9004866105	480/277	10	15 1/2	330.30
A 9004867105	480/277	12	15 1/2	330.30
A 9004854105	480/277	15	16 1/2	330.30
A 9004855105	480/277	15	22	368.10
A 9004856105	480/277	18	15 1/2	330.30
A 9004857105	480/277	7.5	22	368.10
B 9004868105	480	6	12	317.25
B 9004869105	480	9	15 1/2	330.30
B 9004870105	480	12	15 1/2	330.30
B 9004871105	480	18	15 1/2	330.30
B 9004872105	480	15	17 1/2	368.10

Electric Thermostats

ELECTRIC THERMOSTATS

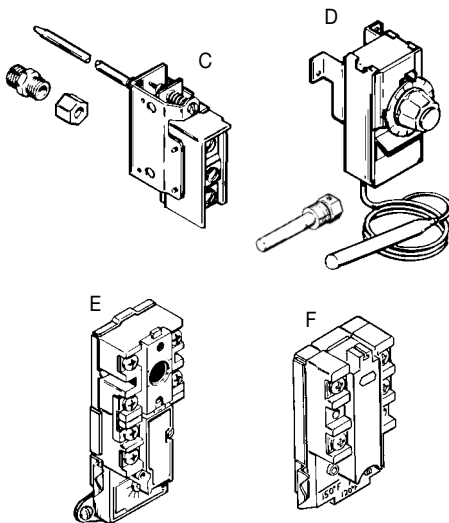

Part Number	Description	List Price
C 9004769105	Single pole, double throw immersion thermostat, temperature range 140°F to 194°F. Used on CM and CMC.	\$ 257.10
D 9005078205	Single pole, single throw, remote bulb, immersion thermostat, temperature range 60°F to 200°F. Used on DVE-52-80-120.	184.05
9005714005	3/4" NPT well. Included with 98368 thermostat. Used on DVE-52-80-120.	75.60
E 9004969215	Single pole, single throw surface mounted thermostat adjustable 120°F to 180°F. Double pole, single throw, manual reset high limit, cutout -200°F. Style 4401 series 59/66T. Used on DRE-52-80-120.	42.50
F 9004533215	Single pole double throw thermostat - w/high limit incorporated as one piece adjustable 120°F to 180°F. Type 89T13. Used on DRE-52-80-120.	33.30

Contactors & Transformers

CONTACTORS

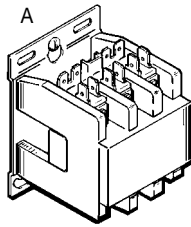

Part Number	Description	List Price
A 9004816105	50* Amp, 120 Volt, three pole contactor.	\$ 130.95
A 9004817105	50* Amp, 120 Volt, four pole contactor.	234.70
A 9005434105	50* Amp, 208/240 Volt, three pole contactor.	165.10
A 9004825105	50* Amp, 480 Volt, three pole contactor.	306.65
A 9005013205	30* Amp, 120 Volt, three pole contactor. (Used only on DVE-52-80-120.)	91.90

* Resistive amps.

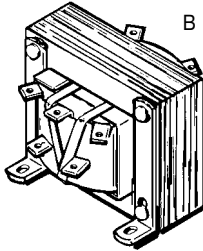

TRANSFORMERS

Part Number	Description	Primary (Line Voltage)	Secondary (Control Circuit Voltage)	VA Capacity	List Price
B 9004830105	Transformer	208/240/480	120	50	\$ 222.90
B 9005012205	Transformer	208/240/277/480	120	100	176.45
B 9005078205	Transformer	240/480	120/240	40	184.05
C 9005916205	Plate mounted transformer	120	25	—	55.85
D 9005901205	Transformer	24 VAC	—	—	32.95

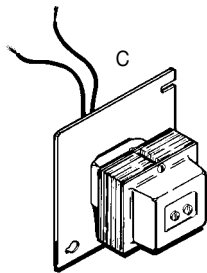

High Limit Controls

HIGH LIMIT CONTROLS

Part Number	Description	List Price
D 9004770105	Single pole, double throw immersion high limit control, manual reset, non-adjustable cutout - 200°F. Used on CM/CMC/DSE.	\$ 259.50
E 9004961205	Single pole, single throw, remote bulb, immersion high limit control, manual reset, non-adjustable cutout - 200°F. Used on DVE-52-80-120.	187.55
F 9004823115	Double pole, single throw surface mounted high limit control, manual reset, non-adjustable cutout - 190°F. Used on some CM/DSE models.	47.20
F 9004824115	Double pole, single throw surface mounted high limit control, manual reset, non-adjustable cutout - 220°F. Used on some CM/SU models.	47.20
G 9004993215	Single pole, single throw surface mounted high limit control, manual reset, non-adjustable cutout - 255°F. Used on copper heat exchanger models.	25.05

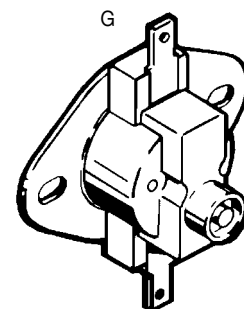
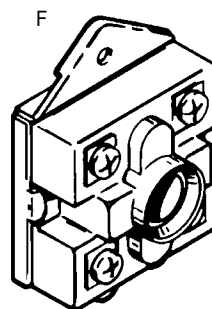
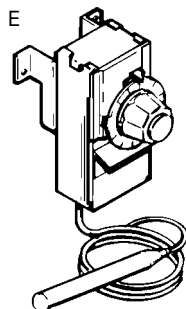
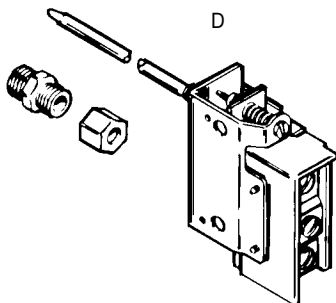

Gas Valves

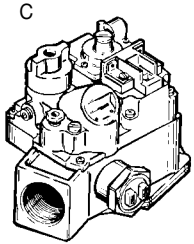
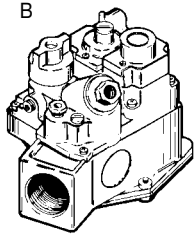
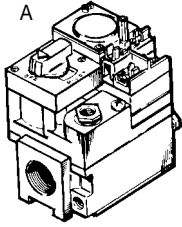

Part Number	Description	List Price
A 9004805105	3/4" PROPANE gas, step opening gas valve, 750 millivolt, 10.5" adjustable main pressure regulator setting. Used on BT-120 thru BT-365.	\$ 299.60
A 9004806105	3/4" NATURAL gas, step opening gas valve, 750 millivolt, 3.5" adjustable main pressure regulator setting. Used on BT-120 thru BT-365.	299.60
A 9004807105	3/4" PROPANE gas, step opening gas valve, 750 millivolt, 10.5" adjustable main pressure regulator setting. Used on standing pilot BT-500.	360.90
B 9004527205	3/4" NATURAL gas, slow opening gas valve, 24 Volt, 3.5" adjustable main pressure regulator setting. Used on I.I.D. model BTC-120 thru BTC-400.	235.80
B 9004528205	3/4" PROPANE gas, slow opening gas valve, 24 Volt, 11" adjustable main pressure regulator setting. Used on I.I.D. model BTC-120 thru BTC-400.	235.80
C 9005017205	1" NATURAL gas, slow opening gas valve, 24 Volt, 3.5" adjustable main pressure regulator setting. Used on BT-500-BTC-500.	442.35
C 9005018205	1" PROPANE gas, slow opening gas valve, 24 Volt, 11" adjustable main pressure regulator setting. Used on BT-500-BTC-500.	469.40
NI 9004494205	1" NATURAL gas - used on Legend Model 500.	547.30
NI 078481-002	1" NATURAL gas - used on Legend Model 750.	506.00
NI 9005022205	1 1/4" NATURAL gas - used on LB/LW-1000	688.85
NI 078482-001	1 1/4" NAT./PROP. gas - used on DB/DW-720 thru 1000	688.85
NI 9004495205	1" PROPANE gas - used on GB/GW	528.45
NI 9004496205	1" NATURAL gas - used on GB/GW	533.20
NI 9004497205	3/4" NATURAL gas - used on HW	331.50
NI 192015-001	3/4" NATURAL gas - used on HW	331.50
NI 9004551205	1" NATURAL gas - used on BTC-500 series 970 and up.	471.25
NI 193366-001	1" PROPANE gas - used on BTC-500 series 971 and up.	443.00
NI 9004507205	3/4" NATURAL gas - used on BTH-250	175.40
NI 9004508205	3/4" PROPANE gas - used on BTH-250	190.20
NI 192454-002	3/4" NATURAL gas - used on GB/GW 200, 300 series 200/202	172.25
NI 192454-003	3/4" NATURAL gas - used on GB/GW 1000-2500 series 200	172.25
NI 9004521205	3/4" NATURAL gas - used on BTH-150,199	212.30
NI 9004535205	1/2" NATURAL gas - used on BTH-120	181.60
NI 9004582205	3/4" NATURAL gas - used on BTI Models	209.95
NI 9004583205	3/4" PROPANE gas - used on BTI Models	214.75

NI = Not illustrated.

Light Commercial Gas Valves

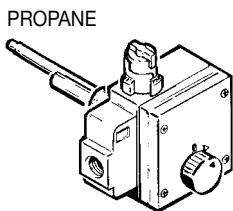
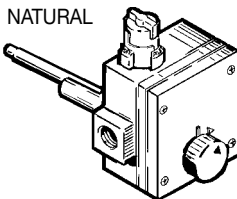

Part Number	Description	List Price
9005891105	NATURAL gas, 96,000 Btuh maximum capacity, 4" main pressure regulator setting, 3" to 4" pilot pressure, energy cutoff at 195°F water temperature, range; warm (120°F) to hot (180°F).	\$ 122.75
9004812105	PROPANE gas, 150,000 Btuh max. cap., 10" main pressure regulator setting; 10" to 12" pilot pressure plus gas inlet screen and baffle, energy cutoff at 195°F water temperature, range; warm (120°F) to hot (180°F). RIGHT HAND THREAD BURNER TUBE CONNECTION.	231.25
9004493105	PROPANE gas, 150,000 Btuh max. cap., 10" main pressure regulator setting; 10" to 12" pilot pressure plus gas inlet screen and baffle, energy cutoff at 195°F water temperature, range; warm (120°F) to hot (180°F). LEFT HAND THREAD BURNER TUBE CONNECTION.	216.35

*Order for replacement on propane heaters manufactured after January 1, 1993.



Pilot Burners

JOHNSON, HONEYWELL, WHITE RODGERS, ROBERTSHAW & MORE

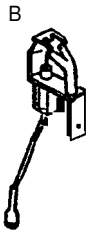
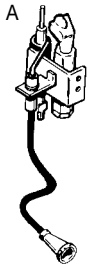

Part Number	Description	List Price
A 9005029115	Johnson pilot burner, natural gas, for use on I.I.D. model heaters.	\$ 115.15
A 9005030115	Johnson pilot burner, propane gas, for use on I.I.D. model heaters.	115.15
A 9005031115	Pilot sensing probe.	22.90
B 9004998215	Honeywell pilot burner.	67.85
B 9004999215	Honeywell pilot burner.	67.85
B 9005000215	Honeywell pilot burner.	67.85
B 9005001215	Honeywell pilot burner.	51.25
B 9004542215	Propane pilot burner for BTC-120 thru 500A series 970 and up.	56.05
B 9004541215	Natural pilot burner for BTC-120 thru 500A series 970 and up.	56.05
C 9004988115	White Rodgers pilot burner, natural gas, for use on I.I.D. model heaters.	86.15
C 9004989115	White Rodgers pilot burner, propane gas, for use on I.I.D. model heaters.	86.15
E 9004479215	Propane gas pilot burner for use with standing pilot heaters.	33.05
F 9005043115	750 millivolt thermopile, 32" long.	44.85
G 9004771115	30 millivolt thermocouple, 36" long with junction block.	19.35
NI 9003925115	60" length of aluminum tubing. Use when tubing has been damaged or is too short after control replacement.	19.15
NI 099041-000	Relight standing gas pilots	240.45
NI 9004534215	Robertshaw pilot burner, natural gas, for use on BTC models series 962	34.35
NI 9004532215	Robertshaw pilot burner, propane gas, for use on BTC models series 963	35.40

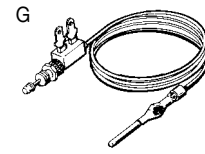
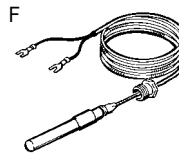
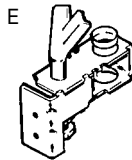
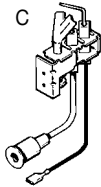

Intermittent Ignition Controls

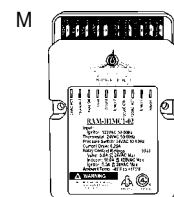
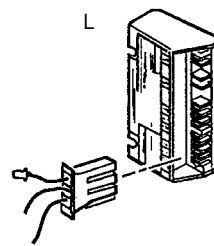
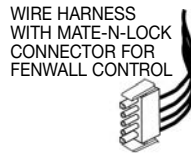
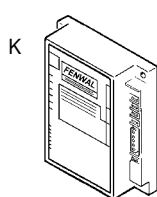
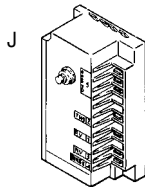
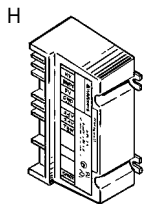

IGNITION CONTROLS

Part Number	Description	List Price
H 9004996105	Honeywell® I.I.D. control - natural gas	\$ 243.00
H 9004997105	Honeywell® I.I.D. control with lockout - propane gas	243.00
J 9004470205	Johnson® I.I.D. control - natural gas	174.50
J 9004471205	Johnson® I.I.D. control with lockout - propane gas	268.90
K 9004487105	Fenwall® I.I.D. control with wire harness for all BTP-540A or 700A series	490.70
L 9004544205	Honeywell® I.I.D. control - nat.& prop. for BTC 120 thru 500A series 970 and up	157.70
L 9004951205	Honeywell® Upgrade Kit for BTC models-nat. & prop.	158.05
M 9004492005	Ram H.S.I Control - Standard Legend Models	447.05
NI 900447205	Honeywell I.I.D. control - natural gas	330.30

Hot Surface Igniters

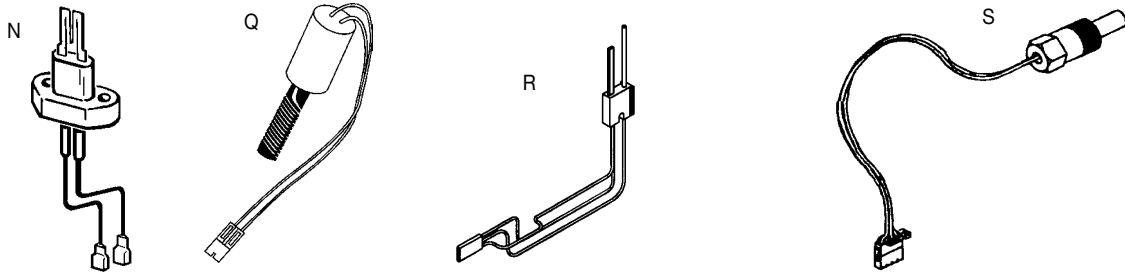

FOR THE LEGEND, GENESIS, CYCLONE & BTP MODELS

Part Number	Description	List Price
N 9004504205	Igniter for Legend 2000 Models LW/LB 1000, LW/LB 500 thru 1000 & Genesis GB/GW 200 thru 750	\$ 80.15
Q 9005902215	Igniter for BTP-540/A & 700/A	117.90
NI 9004566115	Igniter for BTI-80/100, FCGH, FPSH & PGCH-75	146.25
R 9004572205	Silicon Nitride Igniter for Models BTN, BTI	55.85
S 9004238215	Upper Probe Assembly - Model BTH	75.75
S 9004241215	Lower Probe Assembly - Model BTH	62.05

Temperature Controls

MANUAL AND AUTOMATIC TEMPERATURE CONTROLS

Part Number	Description	Tank Opening Size (Inches)	Adjustable Temperature Range - °F (Differential)	Fixed Temperature High Limit		List Price
				Open	Close	
J 9004968105	Automatic reset limit. Includes 5091 lower well and 5090 top well.	3/4	100-180 (Diff. 4)	195	120	\$ 285.50
J 9004531205	Manual reset limit, direct immersion.	3/4	120-180 (Diff. 4)	195	120	306.65
J 9004975105	Automatic reset limit, direct immersion.	3/4	120-180 (Diff. 4)	195	120	278.40
J 9004529005	Manual reset, dual control.	3/4	120-180 (Diff. 4)	205	125	259.50
K 9005044205	Automatic reset limit. Includes 7855 well.	3/4	100-240 (Diff. 5-45)	N/A	N/A	165.10
K 093878-002	Manual reset limit, direct immersion.	3/4	35-110 (Diff. 2)	N/A	N/A	226.95
L 9005072205	Automatic reset limit, direct immersion.	3/4	100-240 (Diff. 5-45)	200	185	332.65
M 9004793105	Direct immersion.	1/2	100-240 (Diff. 10-45)	N/A	N/A	221.70
M 9004506205	Dual Control.	—	—	—	—	470.60
M 9005925205	Tank Temp. - Legend Models.	3/4	100-240 (Diff. 5)	N/A	N/A	222.45

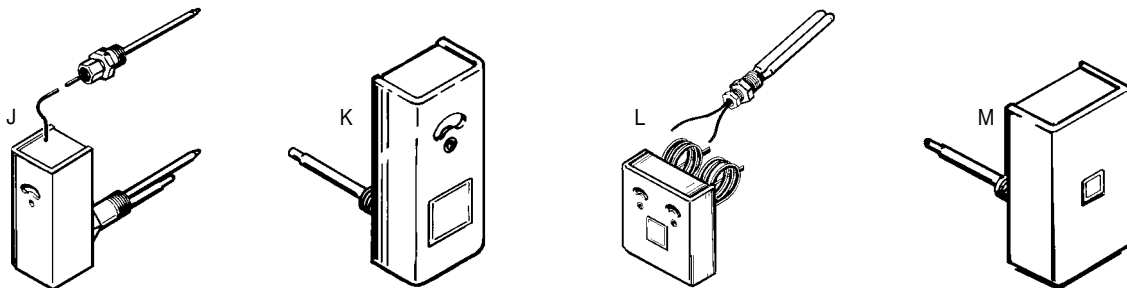

Relief Valves

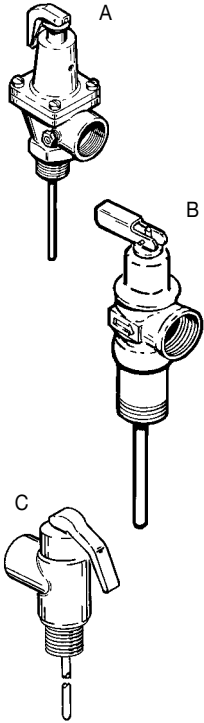

TEMPERATURE & PRESSURE RELIEF VALVES

Part Number	Description	Rated BTU/Hr. ASME	A.G.A.	List Price
A 9005432105	1 1/2", 125#, T & P Relief Valve.	5,125,000	1,200,000	\$ 519.05
A 9003741005	3/4", 150#, T & P Relief Valve.	500,000	100,000	15.20
A 9005899205	3/4", 150#, T & P Relief Valve.	1,912,000	205,000	92.00
A 097560-002	3/4", 125#, T & P Relief Valve.	1,619,000	205,000	94.35
A 097770-000	1", 125#, T & P Relief Valve.	3,070,000	750,000	161.80
B 9006081005	1", 150#, T & P Relief Valve.	2,155,000	500,000	125.05
A 099383-000	3/4", 125#, T & P Relief Valve.	1,619,000	185,000	94.35
A 099383-001	3/4", 150#, T & P Relief Valve.	1,912,000	185,000	94.35
A 099383-002	1", 125#, T & P Relief Valve.	1,825,000	500,000	125.85
A 9005924205	1", 150#, T & P Relief Valve.	2,155,000	500,000	128.10
A 9006187205	1", 150#, T & P Relief Valve.	3,625,000	750,000	170.75
A 099465-004	1", 150#, T & P Relief Valve.	2,155,000	500,000	119.10
A 9005903205	T & P Valve	—	—	\$ 111.05
C 068847-000	1", 150#, Pressure Relief Valve.	3,795,000	—	125.85
C 9005352205	1", 125#, Pressure Relief Valve.	3,215,000	—	164.55
C 090917-003	3/4", 60#, Pressure Relief Valve.	415,000	—	71.90
C 090917-007	1", 65#, Pressure Relief Valve.	1,110,000	—	157.30
C 9006321005	3/4", 30#, Pressure Relief Valve.	480,000	—	68.25
C 097558-000	3/4", 125#, Pressure Relief Valve.	2,289,000	—	79.20
C 097561-000	3/4", 150#, Pressure Relief Valve.	2,703,000	—	78.65
C 098883-000	1" x 1 1/4", 30#, Pressure Relief Valve.	1,331,000	—	184.25

Flue Dampers / Draft Hoods

WITH MOTORIZED FLUE DAMPER

Part Number	Description	List Price
A 9005994105	BTC-120, 154, 179, 197/A, 199/A, 200/A series 962-976, BTR-120, 154, 180/A, 197/A, 198/A, 199/A, 200/A series 104-109	\$ 745.45
A 9005995105	BTC-240/A, 250/A, 251/A, 275/A, 305/A, 365/A, 400/A, 500/A series 962-976. BTR-250/A, 251/A, 275/A, 305/A, 365/A, 400/A, 500/A series 104-109.	802.20
9005934205	Draft Hood Assembly	122.75
9005926205	Draft Hood Assembly	147.45

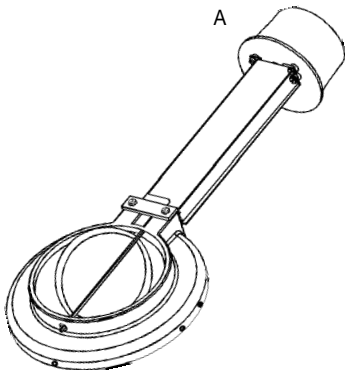

DAMPER SERVICE KIT

Part Number	Description	List Price
9005738005	Damper Service Kit--Contains the damper module for repair and an instruction sheet	\$ 418.35

Coils & Heat Exchangers

COILS AND HEAT EXCHANGERS

	Part Number	Description	List Price
A	9005056205	HW-160P/HW-200P/HW-225P	\$ 1,660.85
A	9005061205	BC-120	1,521.65
A	9004472205	HW-120M thru HW-225M	2,153.90
A	9005058205	BC-160/BC-200 & BC-225	2,465.30
A	9005046205	HW-300	2,625.80
A	9005082205	HW-520 & HW-670	3,071.55
A	9005083205	BC-670	3,071.55
A	9005084205	HW-1240 & HW-1340	3,451.40
B	9005068205	HW-80P/HW-100P	1,630.15
B	9005070205	HW-200P & HW-225	2,059.55
B	9005066205	HW-120M & HW-160M	1,737.45
B	9005067205	BC-200 & BC-225 - HW-200M & HW-225M	2,169.20
B	9005073205	HW-300	2,071.30
B	9005074205	HW-399 & HW-420	1,797.60
B	9005090205	HW-520 & HW-670	3,111.65
B	9005091205	HW-670	2,906.45
B	9005085205	HW-1240 & HW-1340	3,019.65

NOTE: Models shown are for quick reference only. To verify part numbers, check model & series number of heater in appropriate parts list.

Additional parts necessary to change from lead dipped to integral finned are included.

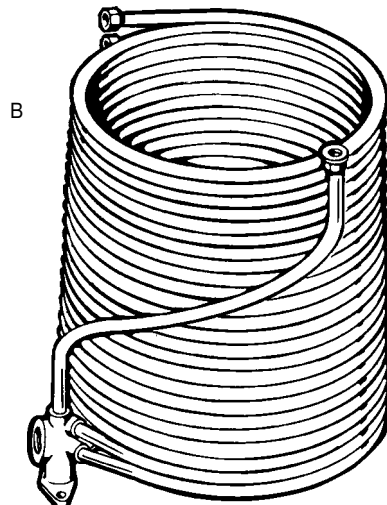
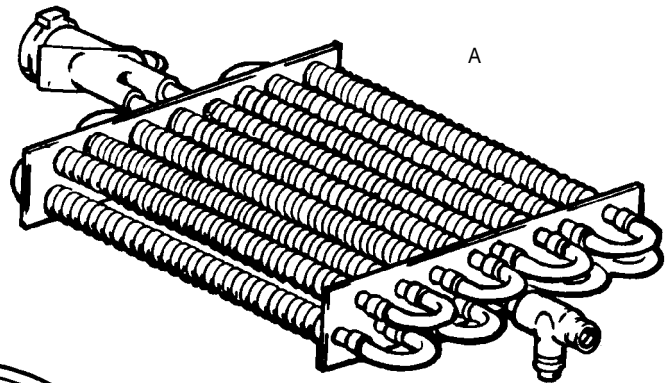

DIRECT FACTORY
REPLACEMENT
COPPER, BRASS AND
BRONZE
CONSTRUCTION

BELL & GOSSETT AND TACO (BRONZE)

Part Number	Bell & Gossett Bronze Body Pumps & Pump Shut-Off Delay Used For Domestic Hot Water Applications	List Price
9005054105	2" All Bronze Pump.	\$ 2,248.30
9005093105	1" HV Bronze Pump - NFI.	1,630.15
9004918105	1 1/2" HV Bronze Pump - NFI.	1,630.15
9004922105	No. 100 1" STD All Bronze Pump.	1,005.05
9005034105	No. 125 1 1/4" STD All Bronze Pump.	1,005.05
9005036105	No. 150 1 1/2" STD All Bronze Pump.	1,005.05
9005038105	2 1/2" All Bronze Pump	3,341.70
9005041105	No. 75 All Bronze Pump.	1,005.05
9005050105	1 1/4" HV Bronze Pump - NFI.	1,630.15
095600-000	3" HD3B All Bronze Pump.	3,914.25

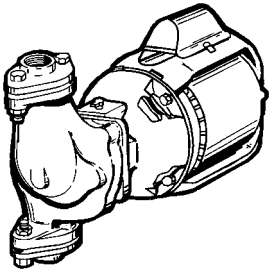

Part Number	TACO Bronze Body Pumps Used for Domestic Hot Water Applications	List Price
9005055205	2" All Bronze Pump 1/7 HP.	\$ 829.25
9005094205	1" All Bronze Pump 1/7 HP.	757.35
9004919205	1 1/2" All Bronze Pump 1/7 HP.	757.35
9005035205	1 1/4" All Bronze Pump 1/15 HP.	578.00
9005037205	1 1/2" All Bronze Pump 1/15 HP.	578.00
9005042105	3/4" All Bronze Pump 1/25 HP.	417.50

THERMAL BALANCER

Part Number	Description	List Price
9005908205	Thermal Balancer (pump shut-off delay switch).	\$ 188.75

Part Number	Iron Body Pumps Used For Hydronic Heating Applications	List Price
9004965205	1 1/4" No. 125 B & G Iron Body Pump.	\$ 566.25
069947-002	2 1/2" B & G Iron Body Pump.	1,684.40

Part Number	Used For Domestic Water Applications	List Price
9004631205	Pump Kit used on LW Model 500 series 920 - 951	\$ 2,203.45
9004632205	Pump Kit used on LW Model 750 series 920-951	3,588.25

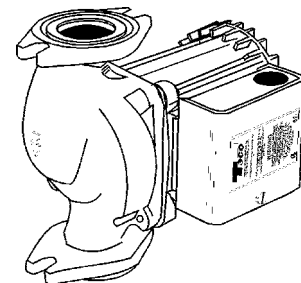

System Packages

CER-TEMP ONE HEATER PACKAGES

CER-TEMP ONE HEATER PACKAGES*		
Part Number	B & G Part Number	List Price
9004896105	6291-10	\$ 1,576.45
9004899105	6291-11-A	1,620.10
9004902105	6291-12-A	1,656.05
9004905105	6291-13-A	2,708.65
9004908105	6291-14-A	3,257.55
*Packages contain Bell & Gosett Circulating Pump		

CER-TEMP ONE HEATER PACKAGES*		
Part Number	TACO Part Number	List Price
9004897105	6291-10-T	\$ 1,044.85
9004900105	6291-11-A-T	1,052.90
9004903205	6291-12-A-T	1,253.70
9004906205	6291-13-A-T	1,371.75
9004909205	6291-14-A-T	1,463.75
*Packages contain TACO Circulating Pump		

PACKAGE CONTENTS*

Qty.	Description
2	Straight Thermometer
1	Angle Thermometer
1	Wall Type Junction Box
1	Tank Temperature Control
1	Safety Flow Switch

CER-TEMP TWO HEATER PACKAGES

CER-TEMP TWO HEATER PACKAGES*		
Part Number	B & G Part Number	List Price
9004917105	6292-9	\$ 1,927.95
9004910105	6292-10-A	2,763.80
9004912105	6292-11-A	3,515.65
9004915105	6292-12-A	3,980.40
*Packages contain Bell & Gosett Circulating Pump		

CER-TEMP TWO HEATER PACKAGES*		
Part Number	TACO Part Number	List Price
9004924105	6292-9-T	\$ 1,361.05
9004911205	6292-10-A-T	1,835.90
9004913205	6292-11-A-T	1,838.25
9004916205	6292-12-A-T	3,263.50
*Packages contain TACO Circulating Pump		

PACKAGE CONTENTS*

Qty.	Description
3	Straight Thermometer
1	Angle Thermometer
1	Wall Type Junction Box
1	Tank Temperature Control
2	Safety Flow Switch

SHURE-TEMP ONE HEATER PACKAGES

SHURE-TEMP ONE HEATER PACKAGES*		
Part Number	B & G Part Number	List Price
9004925105	6293-10-A	\$ 2,127.90
9004926105	6293-11-A	2,217.80
9004927105	6293-12-A	2,491.90
9004929105	6293-13-A	2,850.35
*Packages contain Bell & Gosett Circulating Pump		

SHURE-TEMP ONE HEATER PACKAGES*		
Part Number	TACO Part Number	List Price
9004928205	6293-12-A-T	\$ 1,647.80
9004930205	6293-13-A-T	1,739.20
*Packages contain TACO Circulating Pump		

PACKAGE CONTENTS*

Qty.	Description
1	Straight Thermometer
2	Angle Thermometer
1	Wall Type Junction Box
1	Line Temperature Control
1	Dual Temperature Control
1	Safety Flow Switch
1	Pressure Relief Valve

* Each package contains a correctly sized reducing tees, circulating pumps, T & P valves and pressure relief valves. Packages do not contain water heaters, storage tanks, piping or fittings.

CONCENTRIC VENT KITS FOR CYCLONE

Part Number	Description	List Price
9003910105	BTH 120-300	\$ 138.05
9006144005	BTH 400 & UP	588.50

Legend & Genesis Venting

Commercial

Legend & Genesis Venting

Description	4" Genesis Models		5" Genesis Models		6" Genesis/Legend Models	
	Part Number	List Price	Part Number	List Price	Part Number	List Price
NI Exhaust Vent Cover (Genesis Only)	210418-000	\$ 51.90	9005402205	\$ 55.65	210418-002	\$ 56.60
A Vent Terminal-Horizontal (Legend Only)	210371-000	141.55	210371-001	173.35	210371-002	258.60
B Vent Terminal-Vertical	—	—	—	—	191960-000	439.45
D 6" Length Pipe	191777-002	122.00	191777-003	206.00	191777-000	248.95
D 12" Length Pipe	192039-014	35.40	192039-019	33.70	132039-004	175.70
D 18" Length Pipe	192039-013	40.45	192039-018	44.95	192039-003	53.40
D 2' Length Pipe	9005863105	60.55	9005658105	69.65	9005659105	71.90
D 37.5" Length Pipe	192039-012	69.65	192039-017	76.40	9005919005	85.50
	192039-011	100.60	192039-016	103.35	9005935005	122.75
—	—	—	9005663105	82.60	9005656105	71.90
C 45 Degree Elbows	9005665105	101.10	9005666105	104.85	192031-000	135.15
C 90 Degree Elbows	192032-002	121.35	192032-003	133.85	192032-000	134.80
NI In-line Drain Section 9" Length	210414-000	91.20	210414-001	96.40	210414-002	93.00
F Boot Tee	9005668105	175.25	9005669105	184.25	192034-000	235.30
G Condensate Drain Cover	9005864105	44.95	9005670105	49.45	192036-000	166.40
H Wall Cover Plate	9005375205	22.45	9005378205	22.45	9005376205	22.45
J Roof Jack Support System	192076-002	314.60	192076-003	361.65	192076-000	372.35
L Flex Adapter Coupling (Use with PVC pipe only)	191967-000	33.70	9005671105	47.20	191967-001	50.20
NI Vent Support	500646-000	172.15	—	56.60	9005672105	188.75
NI No. 76 Patch Kit	9005283205	23.55	9005283205	23.55	9005283205	23.55
NI Sealant (General Electric RTV-106) 3 oz Tube	191842-001	15.00	191482-001	15.00	191482-001	15.00

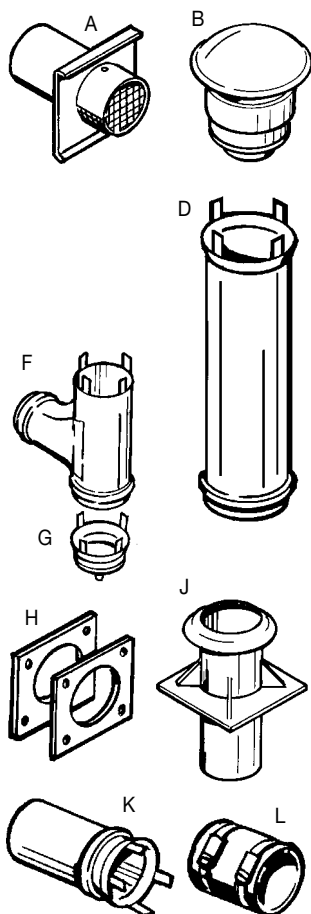

Description	7" Legend Models		8" Genesis Models	
	Part Number	List Price	Part Number	List Price
NI Exhaust Vent Cover (Genesis Only)	—	—	210418-003	\$ 56.60
A Vent Terminal-Horizontal (Legend Only)	—	—	210371-003	366.65
B Vent Terminal-Vertical	191960-001	\$ 1310.00	—	—
D 6" Length Pipe	191777-001	208.05	191777-004	208.05
D 12" Length Pipe	192039-009	61.00	192039-024	40.45
D 18" Length Pipe	192039-008	72.50	192039-023	58.40
D 2' Length Pipe	9005660105	94.35	9005661105	107.85
	192039-007	105.60	192039-022	119.10
D 37.5" Length Pipe	192039-006	146.25	192039-021	168.55
	—	—	9005657105	78.65
C 45 Degree Elbows	192031-001	132.15	9005667105	147.65
C 90 Degree Elbows	192032-001	174.50	192034-004	272.85
NI In-line Drain Section 9" Length	210414-003	96.60	210414-004	116.95
F Boot Tee	192034-001	272.85	9005673105	276.40
G Condensate Drain Cover	192036-001	59.90	9005674105	63.00
H Wall Cover Plate	9005377105	14.25	192111-003	14.25
J Roof Jack Support System	192076-001	444.90	192076-004	489.85
L Flex Adapter Coupling (Use with PVC pipe only)	191967-002	53.95	—	—
NI Vent Support	006566-026	78.45	—	—
NI No. 76 Patch Kit	9005283205	23.55	9005283205	23.55
NI Sealant (General Electric RTV-106) 3 oz Tube	191482-001	15.00	191482-001	15.00

Accessories & Tools

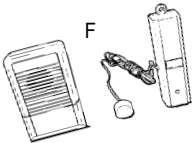
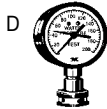
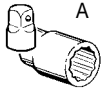

SCREW PLUG ELEMENT REMOVERS TO WIRELESS WATER DETECTIVES

Part Number	Description	List Price
A 9004642115	SCREW PLUG ELEMENT REMOVER-Heavy duty all steel construction with chromium plated finish. Will remove the most stubborn of elements.	\$ 41.95
C 9005033105	GAS PRESSURE GAUGE KIT Includes fittings to check main and pilot pressures. Range of 0" to 15" water column for use on natural and propane gas. Complete with adapters and hose for easy attachment to control or manifold.	152.15
D 9004792105	WATER PRESSURE GAUGE KIT Includes brass reducer and 3/4" female hose fitting. Pressure range from 0 to 200 pounds. 2 1/2" dial face with red maximum indication pointer.	117.90
E 9004653105	DIGITAL MULTIMETER An A.O. Smith exclusive, does 5 essential tests OHM resistance, DC voltage, AC voltage, AC amperage, DC microamps and more. Large 1" digit readout, test leads and instructions.	264.20
F 9005405105	WIRELESS WATER DETECTIVE The wireless water damage alarm is an early warning alarm system that alerts you to any unwanted water due to flooding and other water related damages.	70.20

Series CA-6100 CA-Calc Combustion Analyzers

These portable combustion analyzers are ideal for light commercial to residential applications. Boiler service professionals are provided flue gas data to tune burners on boilers and other heating appliances for safe, efficient operation.

Check out these great features:

- Quality service
- Large display and intuitive operation
- Real-time data provides quick tuning feedback
- 10-hour battery life lowers operating costs
- Automatic base line calibration of sensors
- Recalibrates easily for critical safety checks
- Quick new sensor installation
- Heavy-duty pump designed for field service



Part Number	Description	List Price
9005767105	Combustion Analyzer, w/carrying case O2, CO, Flue & Air Temperature and draft measuring gas analyzer w/probe with thermocouple, water trap with filter, 4 AA Alkaline batteries, Operation and Service Manual, carrying case, power supply, printer and printer charger	\$ 4,401.25
9005768105	Combustion Analyzer, O2, CO, Flue & Air Temperature and draft measuring gas analyzer w/probe with thermocouple, water trap with filter, 4 AA Alkaline batteries, Operation and Service manual.	1,880.20

Accessories & Tools

SEQUENCING/RESETTING CONTROL PANELS

Part Number	Description	List Price
NI 9005409105	2 Stage DB-HW/Boiler Tekmar® Control	\$ 1,552.25
NI 9005410105	4 Stage DB-HW/Boiler Tekmar® Control	2,139.15
NI 9005408105	8 Stage DB-DW/Boiler Tekmar® Control	3,653.60

Tekmar control panels. NI = Not illustrated.

FLUSH VALVE, BRASS AND NYLON DRAIN VALVES

Part Number	Description	Dim. A	Dim. B	List Price
9004635115	3/4" brass sediment flush valve	3"	5"	\$ 46.65
9004772115	3/4" brass drain valve	1 1/16"	2 3/8"	10.40
9003907015	3/4" brass drain valve	3"	4 3/4"	14.85
9001870015	3/4" brass drain valve	2"	3 3/8"	13.90
9002402015	3/4" plastic drain valve	1 1/4"	3 1/5"	3.40
9000679015	3/4" plastic drain valve	1 3/4"	3 3/4"	3.40
9001588015	3/4" plastic drain valve	2 1/2"	4 1/2"	4.60

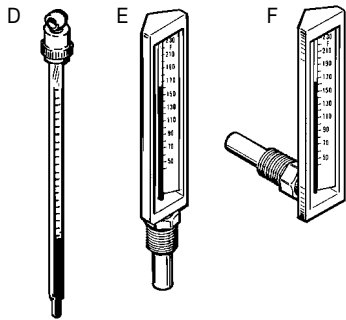
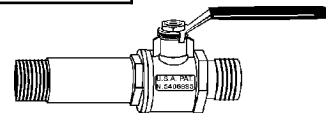
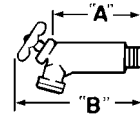

THERMOMETERS

Part Number	Description	List Price
D 9005423105	Max. Registering Service Thermometer, Temp. Range 0°F - 220°F, Mercury Fill.	\$ 148.60
D 9005424105	General Testing Service Thermometer, Temp. Range 0°F - 220°F, Liquid Fill.	69.55
E 9005922105	1/2" NPT, Brass Well, Straight Thermometer, Temp. Range 40°F - 260°F, Liquid Fill.	82.60
F 093155-000	1/2" NPT, Brass Well, Angle Thermometer, Temp. Range 40°F - 260°F, Liquid Fill.	85.40

SAFETY PANS

Part Number	Description	List Price
G 9000741005	Durable, heat resistant aluminum pans are 1-3/4" high, available in three diameters for use underneath heaters approved for combustible floors. Precut side outlet opening. Outlet fitting included. Select 2" larger than heater diameter.	\$ 28.90
9001609005	Durable, heat resistant aluminum pans are 1 3/4" high, available in three diameters for use underneath heaters approved for combustible floors. Precut side outlet opening. Outlet fitting included. Select 2" larger than heater diameter.	34.15
9001608005	Durable, heat resistant aluminum pans are 1 3/4" high, available in three diameters for use underneath heaters approved for combustible floors. Precut side outlet opening. Outlet fitting included. Select 2" larger than heater diameter.	48.60

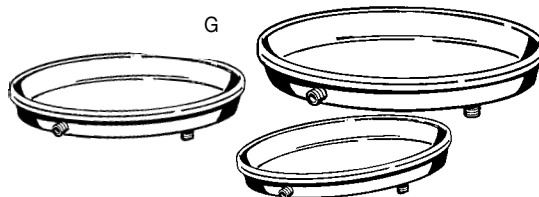

Accessories & Tools

WATER HEATER STANDS

Part Number	Description	List Price
9003331205	WALL MOUNTED TYPE WATER HEATER STAND New, steel adjustable brackets for mounting electric water heaters to wall. Allows mounting of heater overhead to free up useful floor space. 20 gallon maximum.	\$ 73.95
9005743005	WATER HEATER FLOOR STAND Accomodates water heater sizes up to 21" in diameter.	82.40
9005744005	WATER HEATER FLOOR STAND Accomodates water heater sizes up to 24" in diameter.	98.45

SAFETY FLOW SWITCHES, LOW WATER CUT-OFFS & ACCESSORIES

Part Number	Description	List Price
9005541105	Penn F61-KD4 Low Flow Rate 3/4" x 3/4" Safety Flow Switch. HW-120M/160M.	\$ 304.30
9005645105	Penn F61-KD3 1/2" Safety Flow Switch. Dishwasher rinse line.	325.80
L 9005680205	Penn F61-KB variable size (110 - 220V) 1" Safety Flow Switch.	265.15
M 9005545105	Four piece replacement paddle kit for use with 78168 only. HW-200 and up.	25.45
N 210175-000	Low water cut-off - Automatic reset	433.65
N 210175-001	Low water cut-off - Manual reset	480.85

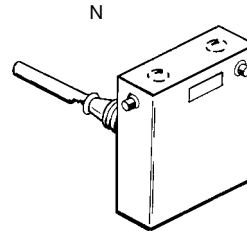
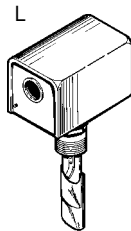

SAFETY FLOW SWITCH REDUCING TEE PACKAGES

Part Number	Description	List Price
NI 9005025115	1" Sweat x 1" Sweat x 1" NPT Reducing Tee.	\$ 99.10
NI 9005026115	1 1/4" Sweat x 1 1/4" Sweat x 1" NPT Reducing Tee.	73.20
NI 9005027115	1 1/2" Sweat x 1 1/2" Sweat x 1" NPT Reducing Tee.	93.95
NI 9005028115	2" Sweat x 2" Sweat x 1" NPT Reducing Tee.	124.65
NI 078542-000	2 1/2" NPT x 2 1/2" NPT x 1" NPT Reducing Tee.	496.60

NI = Not illustrated.

Deliming Goods & Tools

PRODUCT PRESERVERS® Patented Food-Grade Chemicals and Specially Designed Equipment For Professional Deliming Of Gas and Electric Tank & Coil Type Water Heaters

Part Number	Description	List Price
UN•LIME® NON MURATIC DELIMER		
H 9005416105	1 Gallon size, plastic, case of four (4).	\$ 248.25
9005417105	5 Gallon size, plastic, (1) one per case.	265.90
	<ul style="list-style-type: none"> • For all water heaters, heating, cooling, evaporation & humidification equipment. • Powerful, patented A.O. Smith UN•LIME® is ready to use without mixing or diluting. 	
UP-N-DOWN® GRAVITATIONAL DELIMING KIT WITH UN•LIME® DELIMER FOR USE IN GAS, OIL & ELECTRIC TANK TYPE WATER HEATERS		
J 9005419105	RESIDENTIAL USE - Complete kit includes vented plastic jug, tubing, clamps, instructions, and 3 gallons of UN•LIME® Delimer for small and medium residential heaters.	\$ 359.95
J 9005420105	COMMERCIAL USE - Same as above but includes 5 gallons of UN•LIME Delimer for larger Residential and Commercial Heaters	404.45
NI 9005418105	Replacement hose package only includes tubing, clamps, fittings and instructions for use with plastic jugs and UN•LIME® Delimer. (Same accessories as furnished with 4813-3 & 4813-5 UP-N-DOWN Deliming Kits).	136.95
MOTORIZED DELIMING PUMP KIT FOR USE WITH UN•LIME® DELIMER IN COIL AND HEAT EXCHANGER TYPE WATER HEATERS		
NI 9004795105	Acid pump deliming kit includes 4920-2 pump, 2 containers, hose clamps, tubing, fittings and instructions (Order UN•LIME® separately).	\$ 810.40
NI 9005426105	Replacement acid pump only.	600.60
MAG-ERAD® NON-TOXIC CLEANER FOR NOISY TANK TYPE RESIDENTIAL GAS WATER HEATERS		
	<p>As published in "This Old House" (Do-It-Yourself).</p> <ul style="list-style-type: none"> • In concentrated powder form • No special equipment required • Minimum 2-1Lb. cans for 30 to 40 gallon size heaters, more required for larger sizes. • Minimum 2-1Lb. cans for 30 to 40 gallon size heaters, more required for larger sizes. 	
NI 9005413105	1 Lb. can of Mag-Erad®	\$ 34.80
NI 9005778105	12-1Lb. cans of Mag-Erad®	283.10
FLUSHING TOOL		
NI 9004667105	<p>36" of aluminum tubing with fittings.</p> <ul style="list-style-type: none"> • For more efficient cleaning when flushing heater after deliming attach tool to hose, drain tank, remove drain valve, direct tool through opening and flush. 	\$ 18.10

NI = Not illustrated.

UN•LIME®

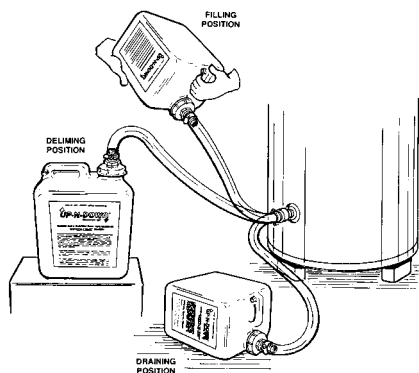
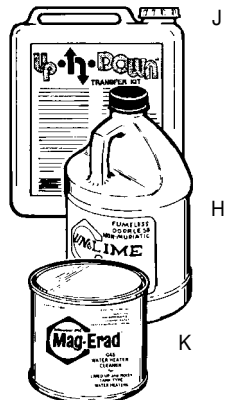

Up•h•Down®
TRANSFER KIT

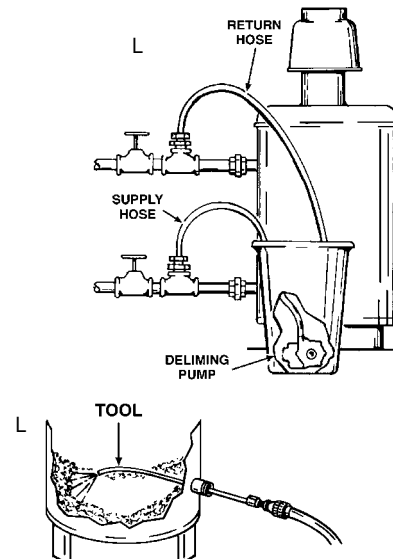

Accessories

Deliming Goods & Tools

Main Burner Assembly Guide

MAIN BURNER ASSEMBLY GUIDE

Part Number	Description	Where Used		List Price
		Model	Series	
183087-002	Main Burner Assembly	FPD-40	251	\$ 172.25
182725-001	Main Burner Assembly	FSGH-30	231/233/241	73.70
182725-004	Main Burner Assembly	FSG-50, FSGH-50, PGXH-50	230/232/240	73.70
182725-005	Main Burner Assembly	FSG-50, FSGH-50	231/233/241	73.70
182725-008	Main Burner Assembly	FSG-40	230/232/240	73.70
182725-009	Main Burner Assembly	FSG-40	231/233/241	73.70
182725-012	Main Burner Assembly	FSG-30	230/232/240	73.70
182725-013	Main Burner Assembly	FSG-30	231/233/241	73.70
182725-015	Main Burner Assembly	FGR-30, FSGH-40, PGXH-30	230/232/236/240	73.70
182725-016	Main Burner Assembly	FGR-30, FSGH-40	231/233/237/241	73.70
182725-018	Main Burner Assembly	FSGL-30, PGXL-30	230/232/240	73.70
182725-019	Main Burner Assembly	FGR-40	234/236/240D	73.70
182725-020	Main Burner Assembly	FGR-40	237/241	73.70
182725-024	Main Burner Assembly	FGR-50, PGCL-40	236/240/240D	73.70
182725-025	Main Burner Assembly	FGR-50	237/241	73.70
180653-005	Main Burner Assembly	FGR-100	224/230	102.60
9005100105	Main Burner Assembly	FGR-30	224	66.65
181786-000	Main Burner Assembly	FGR-75	225/231	125.10
181786-002	Main Burner Assembly	FGR-75	233	97.25
182357-000	Main Burner Assembly	FPST-50	225/231	96.75
183265-000	Main Burner Assembly	FPST-50	225/227	194.65
183266-000	Main Burner Assembly	FPST-50	230/234	194.65
183007-001	Main Burner Assembly	FPSH-50	250	86.15
183007-002	Main Burner Assembly	FPSH-40	251	86.15
183416-000	Main Burner Assembly	FPSH-40	234/236	127.35
183416-001	Main Burner Assembly	FPSH-50	234/236	127.35
183416-002	Main Burner Assembly	FPSH-40	235/237	127.35
183416-003	Main Burner Assembly	FPSH-50	250	127.35

FVIR BURNER ASSEMBLIES

Part Number	Description	Where Used		Gas Type	List Price
		Model	Series		
9003382005	Main Burner Assembly	FCV/GCV/PCV/XCV-50	100	Natural	\$ 64.00
9003546005	Main Burner Assembly	FCV/GCV/PCV/XCV-50	101	Propane	64.00
9003504005	Main Burner Assembly	FVG/GVG-40	100	Natural	64.00
9003547005	Main Burner Assembly	FVG/GVG-40	101	Propane	64.00
9003502005	Main Burner Assembly	FVG-30	100	Natural	64.00
9003548005	Main Burner Assembly	FVG-30	101	Propane	64.00
9003549005	Main Burner Assembly	FCVT/GCVT/PCVT/XCVT/CVT-40, GCVT/XCVT-40Q, GCVT/XCVT-40L	100	Natural	64.00
9003550005	Main Burner Assembly	FCVT/GCVT/PCVT/XCVT/CVT-40, GCVT/XCVT-40Q, GCVT/XCVT-40L	101	Propane	64.00



Main Burner Assembly Guide

FVIR BURNER ASSEMBLIES - Continued

Part Number	Description	Where Used		Gas Type	List Price
		Model	Series		
9003383005	Main Burner Assembly	FCVT/GCVT/PCVT/XCVT/CVT-50, GCVT/XCVT-50Q, GCVT/XCVT-50L	100	Natural	\$ 64.00
9003551005	Main Burner Assembly	FCVT/GCVT/PCVT/XCVT/CVT-50, GCVT/XCVT-50Q, GCVT/XCVT-50L	101	Propane	64.00
9003552005	Main Burner Assembly	FCVL/GCVL/PCVL/XCVL-30	100	Natural	64.00
9003553005	Main Burner Assembly	FCVL/GCVL/PCVL/XCVL-30	101	Propane	64.00
9003379005	Main Burner Assembly	FCVL/GCVL/PCVL/XCVL-40	100	Natural	64.00
9003554005	Main Burner Assembly	FCVL/GCVL/PCVL/XCVL-40	101	Propane	64.00
9003380005	Main Burner Assembly	FCVH/GCVH/PCVH/XCVH-30	100	Natural	64.00
9003550005	Main Burner Assembly	FCVH/GCVH/PCVH/XCVH-30	101	Propane	64.00
9003556005	Main Burner Assembly	FVR/GVR/PVR/XVR-30	100	Natural	64.00
9003557005	Main Burner Assembly	FVR/GVR/PVR/XVR-30	101	Propane	64.00
9003381005	Main Burner Assembly	FCVH/GCVH/PCVH/XCVH-40, GCVH/XCVH-40Q, GCVH/XCVH-40L	100	Natural	64.00
9003384005	Main Burner Assembly	FCVH/GCVH/PCVH/XCVH-40, GCVH/XCVH-40Q, GCVH/XCVH-40L	101	Propane	64.00
9003558005	Main Burner Assembly	FVR/GVR/PVR/XVR-40	100	Natural	64.00
9003559005	Main Burner Assembly	FVR/GVR/PVR/XVR-40	101	Propane	64.00
9003560005	Main Burner Assembly	FVR/GVR/PVR/XVR-50	100	Natural	64.00
9003470005	Main Burner Assembly	FVR/GVR/PVR/XVR-50	101	Propane	64.00
9003561005	Main Burner Assembly	FCV/GCV/PCV/XCV-30	100	Natural	64.00
9003562005	Main Burner Assembly	FCV/GCV/PCV/XCV-30	101	Propane	64.00
9003563005	Main Burner Assembly	FCV/GCV/PCV/XCV-40	100	Natural	64.00
9003564105	Main Burner Assembly	FCV/GCV/PCV/XCV-40	101	Propane	64.00
9003477005	Main Burner Assembly	FVGL/GVGL-30	100	Natural	64.00
9003566005	Main Burner Assembly	FVGL/GVGL-30	101	Propane	64.00
9003485005	Main Burner Assembly	FVGL/GVGL/PVGL/XVGL-40	100	Natural	64.00
9003567005	Main Burner Assembly	FVGL/GVGL/PVGL/XVGL-40	101	Propane	64.00
9003506005	Main Burner Assembly	FVG/GVG-50	100	Natural	64.00
9003568005	Main Burner Assembly	FVG/GVG-50	101	Propane	64.00
9003515005	Main Burner Assembly	PGV/XGV/PCVD-40, XGV-40L	100	Natural	64.00
9003569005	Main Burner Assembly	PGV/XGV/PCVD-40, XGV-40L	101	Propane	64.00
9003516050	Main Burner Assembly	PGV/XGV/PCVD-50, XGV-50L	100	Natural	64.00
9003570005	Main Burner Assembly	PGV/XGV/PCVD-50, XGV-50L	101	Propane	64.00
9003571005	Main Burner Assembly	PGVL/XGVL-40	100	Natural	64.00
9003572005	Main Burner Assembly	PGVL/XGVL-40	101	Propane	64.00
9003573005	Main Burner Assembly	FCVX/GCVX/PCVX/XCVX-50, GCVX/XCVX-50Q, GCVX/XCVX-50L	100	Natural	64.00
9003574005	Main Burner Assembly	FCVX/GCVX/PCVX/XCVX-50, GCVX/XCVX-50Q, GCVX/XCVX-50L	101	Propane	64.00
9003991005	Main Burner Assembly	FCVL/GCVL/PCVL/XCVL-50	100	Natural	64.00
9003992005	Main Burner Assembly	FCVL/GCVL/PCVL/XCVL-50	101	Propane	64.00

For High Altitude Burner Assemblies call Customer Service.

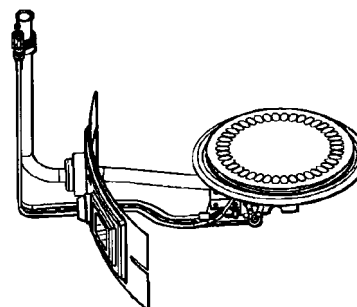

Burner Reference Guide

BURNER REFERENCE GUIDE

Part Number	Description	Where Used		List Price
		Model	Series	
182165-003	Pilot Burner Assembly	FGR-30/40/50, FSG-30/40/50, FSGH-30/40/50, FSSL-30/40/50, PGXH-30/40/50, PGXL-30/40	230/232/236	\$ 17.85
182165-004	Pilot Burner Assembly	FGR-30/40/50, FSG-30/40/50, FSGH-30/40/50, FSSL-30/40/50	231/233/237	17.85
9004339115	Pilot Burner Assembly	FGR-75/100, FSG-75/100	224/230/232	10.60
9004231005	Pilot Burner Assembly	FGR-75/100, FSG-75/100	225/231/233	10.05
9004371115	Pilot Burner Assembly	FGCG-40/50, PGCG-40/50	223/225/227	28.80
9004372115	Pilot Burner Assembly	FGCG-40/50, PGCG-40/50	222/224/226	28.80
182729-001	Pilot Burner Assembly	Propane - Orifice Size - .007	—	19.45
182729-010	Pilot Burner Assembly	Natural - Orifice Size - .0125	—	19.45
9004375115	Pilot Igniter Assembly	FPSE-40/50	226/230	39.95
9004384115	Pilot Igniter Assembly	FPS-75, FPSE-40/50/75, FPST-50	230/232/234/240	26.30
9004385115	Pilot Igniter Assembly	FPS-75, FPSE-40/50/75, FPST-50	231/233/235/241	26.30
183014-000	Pilot Igniter Assembly	FPSH-40/50	236	48.70
183014-001	Pilot Igniter Assembly	FPSH-40/50	237	48.70
9005107105	Hot Surface Ignitor	FPD-40/50	230/231/234/235	67.85
9005256015	Hot Surface Ignitor	FPSH-40/50, FPST-50	250/251	107.35
9004455105	Hot Surface Ignitor	FPST-50	250	164.55
9004448105	Hot Surface Ignitor	FPD-40/50	250/251	87.30
9004417115	Spark Ignitor	FGT-75/100	230/231/234	136.85
9004430105	Ignition Control Module	FPD-40/50	230/231234/235	127.35
9004426105	Ignition Control Module	FPS-75, FPSE-40/50/75	226/230/231/232/233	122.60
9004383105	Gas Valve	FPSE-40/50, FPST-50	226/230/234	172.80
9004418105	Gas Valve	FPST-50	231/235	191.10
9004422105	Gas Valve	FPD-40/50	230/234	129.80
9004423105	Gas Valve	FPD-40/50	231/235	129.80
9004420105	Gas Valve	FPS-75, FPSE-75	230/232/234	185.20
9004421105	Gas Valve	FPS-75, FPSE-75	231/233/235	251.25
9004354105	Blower Assembly	FPV/KPV/FPVH	—	378.65
9004363105	Blower Assembly	FPS	—	450.60
181616-000	Blower Assembly	FPSE-40/50	226/230	428.15
9004419105	Blower Assembly	FPS-75, FPSE-75	230/231/232/233/234/235	452.95
9004425105	Blower Assembly	FPD-40/50	230/231/234/235	420.00
9004434105	Blower Assembly	FPSH-40/50	234/235	483.65
9004449105	Blower Assembly	FPD-40/50	250/251	451.75
9004453105	Blower Assembly	FPSH-40/50	236/237	435.30
9004305005	Blower Assembly	FPST-50	250/251	636.95
9004456105	Blower Assembly	FPSH-40/50	250/251	424.70
9004306105	Blower Assembly	FPSH-40/50, FPCR 40/50	260/261	375.05
9004565105	Blower Assembly	BTI-80/100	104/105	444.70
9004568105	Blower Assembly	FPSE-75	250/251	592.15
9004581205	Blower Assembly	BTF-75, FPSH-75	100/101/260	375.05
9004656105	Blower Assembly	FPS-40/50	—	420.00
9004374115	E.C.O.	FPD-40/50, FPSE-40/50, FPST-50	226/230/231/234/235	11.45
9004373115	Thermostat	FPD-40/50, FPSE-40/50, FPST-50	226/230/231/234/235	15.00
9004400205	Transformer	FPD-40/50, FPST-50	230/231	67.10
9004515205	Transformer	FPD-40/50, FPSE-40/50, FPST-50	234/235	43.25

Part Number	Description	List Price
9003541005	FV PILOT ASS'Y 160° - PROPANE	\$ 39.40
9003444005	FV PILOT ASS'Y 170° - NATURAL	39.40
9003488005	FV PILOT ASS'Y 170° - HIGH ALTITUDE	39.40
9003472005	FV PILOT ASS'Y 170° - PROPANE	39.40
9003459005	FV PILOT ASS'Y 180° - NATURAL	39.40
9003531005	FV PILOT ASS'Y 180° - HIGH ALTITUDE	39.40
9003455005	FV PILOT ASS'Y 180° - PROPANE	39.40
9003542005	FV PILOT ASS'Y 190° - HIGH ALTITUDE	39.40
9003543005	FV PILOT ASS'Y 190° - PROPANE	39.40
9003521005	FV PILOT ASS'Y 200° - HIGH ALTITUDE	39.40
9003544005	FV PILOT ASS'Y 200° - PROPANE	39.40
9003521005	FV PILOT ASS'Y 200° - HIGH ALTITUDE	39.40
9003544005	FV PILOT ASS'Y 200° - PROPANE	39.40

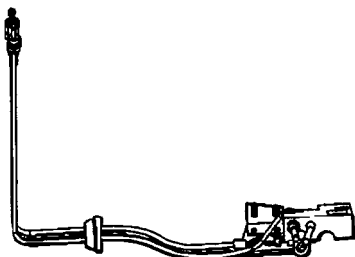

Contact Information

A. O. Smith Water Heaters

500 Tennessee Waltz Parkway • Ashland City, TN 37015

To place a parts order or for information regarding your parts order:

- Telephone: 800-433-2545
- Fax: 800-433-2515

To verify your water heater warranty information call:

- The Warranty Information Center - 800-323-2636
- Visit On-Line: www.hotwater.com - Click "Warranty Information"

For technical assistance or information regarding your A. O. Smith water heater call:

- Technical Support Center - 800-527-1953
- E-mail us: help@hotwater.com



Information

A.O. Smith
Water Heaters

500 Tennessee Waltz Parkway • Ashland City, Tennessee 37015

For more information:

Call: 800-433-2545 • Fax: 800-433-2515

This parts price catalog supercedes Book Number ASMCA00306